

BLX-II LED Specifications

Area - Site - Sports - Tennis - Pickleball - Outdoor

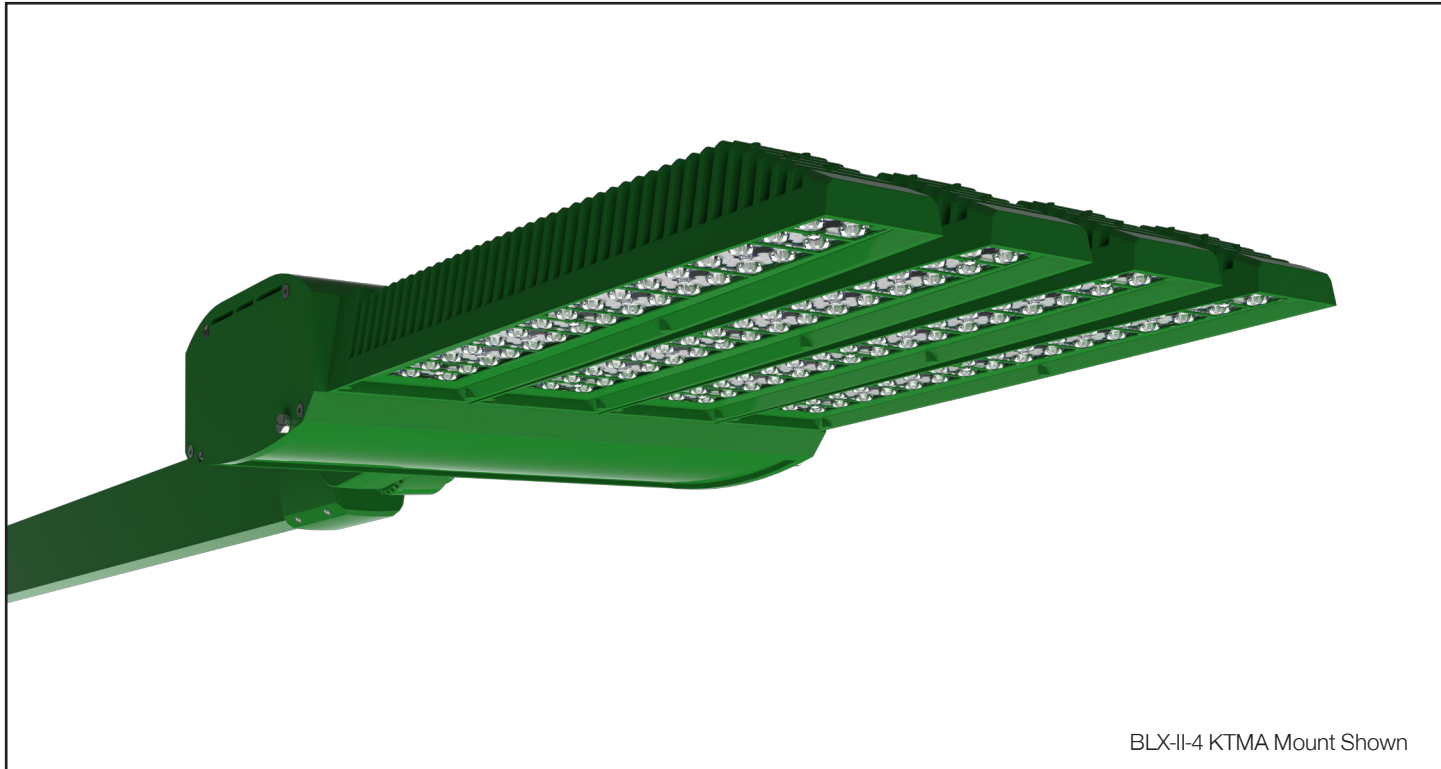

BLX-II-4 KTMA Mount Shown

The BOW LX II LED Series brings signature contemporary design to high-performance tennis and pickleball court lighting—delivering the punch, precision, and visual comfort players demand, with the architectural presence facility owners want. Built for competitive play and club-level environments alike, BOW LX II provides bright, uniform illumination that supports faster reaction time, better ball tracking, and a more professional on-court experience—game after game, season after season.

Its advanced construction separates a robust extruded-aluminum driver housing from individual die-cast aluminum linear LED engines, maximizing thermal management to extend component life and maintain high output over time. A field-adjustable knuckle with up to 50° of vertical aiming gives installers and designers exceptional control—dialing in coverage for full-court uniformity while helping minimize glare and unwanted spill beyond the fence line.

Each linear LED engine contains 32 high-performance LEDs, configurable up to 256 LEDs per fixture, with flexible 2700K, 3000K, 3500K, 4000K, or 5000K CCT options and 70, 80, or 90 CRI to match the atmosphere and visual clarity your venue requires. With seventeen precision-engineered optical distributions, BOW LX II directs light exactly where it matters—supporting consistent court brightness, improved visibility at the baseline and net, and a cleaner overall site presentation.

Project Name:

Catalog Number:

Type:

Date:

Location:

Engineered for large-scale performance, BOW LX II delivers up to 126,000 lumens with wattage packages up to 966 watts, achieving an impressive 141 lumens per watt. Integrated lighting controls add another layer of value—enabling scheduling, dimming, and energy optimization for practices, open play, and tournament nights, while supporting long-term operating savings.

Finished in a durable polyester powder coat (guaranteed for five years) and available in standard or custom colors, BOW LX II complements modern athletic facilities and upscale club environments with a refined, specification-grade aesthetic.

From private clubs and parks to schools and multi-court complexes, the BOW LX II is a standout solution for tennis and pickleball sports lighting—combining elite output, precision aiming, optical control, and architectural design to elevate every match.

MODEL	OPTICS		LEDs	CURRENT	CCT
BLX-II-3	T1 Type 1	T5 Type 5	96LD	3 350mA	27K7 27K8 27K9 2700K 70, 80, & 90 CRI
BLX-II-4	T2 Type 2	T5W Type 5 Wide	128LD	5 530mA	30K7 30K8 30K9 3000K 70, 80, & 90 CRI
BLX-II-6	T3 Type 3	T5WW Type 5 Extra Wide	192LD	7 700mA	35K7 35K8 35K9 3500K 70, 80, & 90 CRI
BLX-II-8	T3R Type 3 Round	T5LG Type 5 Low Glare	256LD	10 1050mA	40K7 40K8 40K9 4000K 70, 80, & 90 CRI
	T3W Type 3 Wide	FN Flood Narrow		12 1200mA	50K7 50K8 50K9 5000K 70, 80, & 90 CRI
	T3LG Type 3 Low Glare	FM Flood Medium			
	T4 Type 4	FW Flood Wide			
	T4T Type 4 Tennis				
	T4FT Type 4 Forward Throw				
	T4LG Type 4 Low Glare				

VOLTAGE	MOUNTING	FINISH	CONTROL OPTIONS	SHIELD OPTIONS	OPTIONS
UNV 120-277V	KMTA Tenns Knuckle Mount	BZ Bronze	PCR-120 PCR-208 PCR-240 PCR-277 PCR-347 PCR-480 Photocell & Receptacle	CLS Backside cutoff shield	RPP-3" RPP-4" RPP-5" Round Pole Plate Adaptor
8 347V	PT Post Top	BK Black	PC-120 PC-208 PC-240 PC-277 Button Type Photocell	RCLS Rightside cutoff shield	DS Decorative Shroud
5 480V	MA Mast Arm Fitter	GY Grey	7PINPER 7 Pin Photo Receptacle w/shorting cap Requires Dimming Driver	LCLS Leftside cutoff shield	ROT-R Rotated Optics Right Side
	KM Knuckle Mount	SBK Smooth Black	DIM 0-10v Dimming Driver No Controls	BHS House shield	ROT-L Rotated Optics Left Side
	BOA Bolt-On Arm	WH White	DTO Dim to Off Driver		UPMA-S Universal Square Pole Mount Adaptor * Not available with BLX-II-8
	TM Trunnion Mount	SWH Smooth White	WSP6-L2 WSP6-L3 WSP6-L7 8' 9-20' 21-40' Mounting Mounting Mounting Height Height Height		UPMA-R Universal Round Pole Mount Adaptor * Not available with BLX-II-8
		GP Graphite	WSC-8 WSC-20 WSC-40 8' 9-20' 21-40' Mounting Mounting Mounting Height Height Height		BBG Bird Spikes
		GY Grey	*The WSC option will require (1) FSIR 100 remote for programming		BAA Buy America(n) Act Compliant
		SL Silver Metallic	TL7 7-PIN Twist-lock Wireless Control		BABA Build America Buy American
		ZFP Zinc-Free Primer Coat	Z10 or Z18 Zhaga 4 Pin Receptacle		
		CC Custom Color	VWC Visionaire Wireless Control		

Housing

The LED light engines are constructed of heavy-duty, die-cast aluminum, with external heat radiating fins.

Driver Compartment

The separate driver housing is constructed of extruded aluminum, with vented cast aluminum end covers and stainless steel fasteners; for easy access to the LED driver(s); allowing for cooler operation and longer driver life. One-piece gasketing is utilized throughout the fixture for weather tight operation.

Thermal Management

The BOW LX II Series provides excellent overall thermal management by maximizing the fixture's heat sink capabilities. This enables the BOW LX II Series to withstand higher ambient temperatures and drive currents without degrading LED life.

The L70 test determines the point in an LEDs life when it reaches 70 percent of its initial output. The BOW LX II Series LEDs have been determined to last a minimum of 100,000 hours in 25 °C environments when driven at 350 mA.

Optical System

The highest lumen output, LEDs are utilized in the BOW LX II Series. Available with 17 IES distribution patterns. LED light engines come in multiples of 32 LEDs.

- CRI values are 70, 80 or 90.
- CCT values are 2700K, 3000K, 3500K, 4000K, 5000K

Quali-Guard® Finish

The finish is a Quali-Guard® textured, chemically pretreated through a multiple-stage washer, electrostatically applied, thermoset polyester powder coat finish, with a minimum of 3-5 mils thickness. Finish is oven-baked at 400 °F to promote maximum adherence and finish hardness.

- All finishes are available in standard and custom colors.
- Optional Zinc-Free Primer - Recommended within three miles of the ocean
- Finish is guaranteed for five (5) years.

Mounting

An adjustable Tennis knuckle slip fits over a traditional Tennis Arm, and allows for up to 50° degrees of vertical adjustment in 10° degree increments from horizontal. The Bolt -On Arm (BOA) utilizes a 2 piece cleat system for easy installation. A Round Pole Plate Adaptor (RPP) is required for mounting to round poles.

- Mast Arm Fitter fits over a 2 3/8" tenon.
- Post Top fits over a 2 3/8" tenon and is adjustable up to 45°.
- Trunnion Mount is adjustable up to 50°

Electrical Assembly

The BOW LX II Series is supplied with a choice of 350, 530, 700, 1050 or 1200 mA high-performance LED drivers, that accept 120v thru 480v, 50 Hz to 60 Hz, input.

- Rated for -40 °C to +55 ° C operations.
- Power factor of 90%.
- THD less than or equal to 20%
- 20 kV surge protector supplied as standard.
- 0-10v Dimming Driver supplied as standard.

Warranty

Five (5) year Limited Warranty on entire system, including finish. For full warranty information, please visit VisionaireLighting.com.

Options

- Wattstopper Plus
- Wattstopper FSP-211 Motion Sensor/Control
- Photocell & Receptacle
- Button Type Photocell
- 7 Pin Photo Receptacle
- Dimming Driver
- Dim To Off Driver
- Wireless Controls
- Zhaga 4 Pin Receptacle
- Round Pole Plate Adapter
- Universal Pole Mount Adapter
- Decorative Shroud
- Rotated Optics
- Cut-off Louver Shield
- Bird Spikes
- BAA / BABA

Listings

- BOW LX II Series is UL listed, suitable for wet locations
- Meets ANSI C136.31-2010 3G Vibration Standards
- Powder Coated Tough™
- IP-66 Rated
- IDA Certification
- Pangealink



3000K or lower must be selected with a fixed mount for IDA certification.
Fixed mount must be selected for IDA dark sky certification.

Photometric Optical Summary

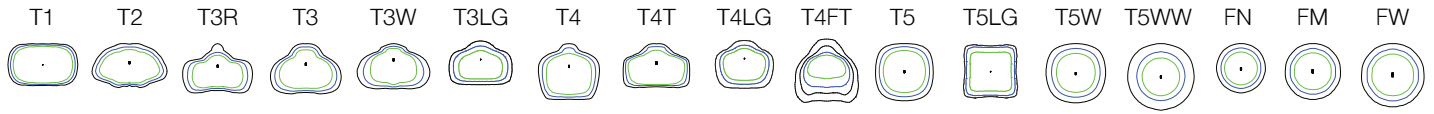

Dimensions

Post Top		Mast Arm		Knuckle Mount		Bolt-On Arm		Trunnion	
Width:	BLX-II-3 15" BLX-II-4 17" BLX-II-6 28" BLX-II-8 33"	Width:	BLX-II-3 15" BLX-II-4 17" BLX-II-6 28" BLX-II-8 33"	Width:	BLX-II-3 15" BLX-II-4 17" BLX-II-6 28" BLX-II-8 33"	Width:	BLX-II-3 15" BLX-II-4 17" BLX-II-6 28" BLX-II-8 33"	Width:	BLX-II-3 15" BLX-II-4 17" BLX-II-6 28" BLX-II-8 33"
Depth:	BLX-II-3 36" BLX-II-4 36" BLX-II-6 36" BLX-II-8 36"	Depth:	BLX-II-3 36" BLX-II-4 36" BLX-II-6 36" BLX-II-8 36"	Depth:	BLX-II-3 37" BLX-II-4 37" BLX-II-6 37" BLX-II-8 37"	Depth:	BLX-II-3 34" BLX-II-4 34" BLX-II-6 34" BLX-II-8 34"	Depth:	BLX-II-3 33" BLX-II-4 33" BLX-II-6 33" BLX-II-8 33"
Height:	BLX-II-3 6" BLX-II-4 6" BLX-II-6 6" BLX-II-8 6"	Height:	BLX-II-3 5" BLX-II-4 5" BLX-II-6 5" BLX-II-8 5"	Height:	BLX-II-3 5" BLX-II-4 5" BLX-II-6 5" BLX-II-8 5"	Height:	BLX-II-3 5"/9" BLX-II-4 5"/9" BLX-II-6 5"/9" BLX-II-8 5"/9"	Height:	BLX-II-3 5" BLX-II-4 5" BLX-II-6 5" BLX-II-8 5"

Post Top

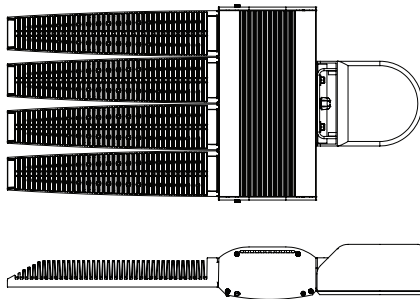

Mast Arm

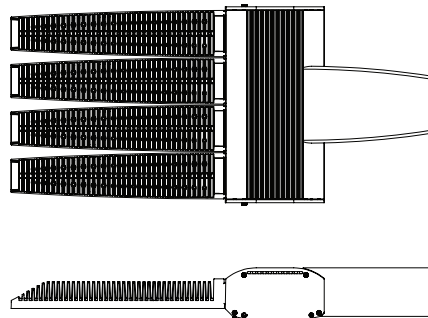

Knuckle Mount

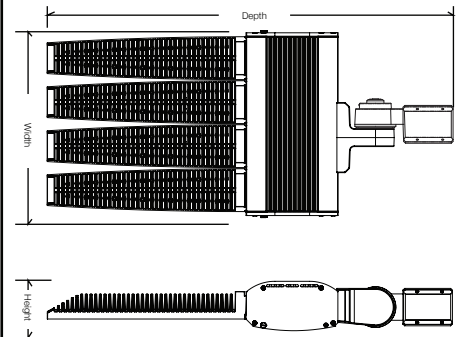

Bolt-On Arm

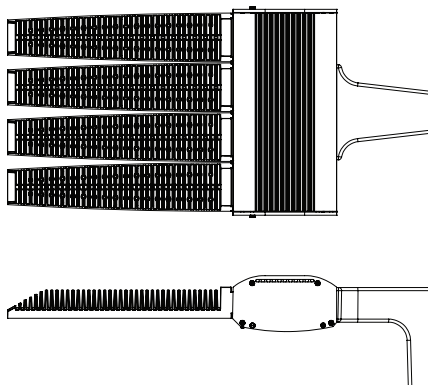

Trunnion Mount

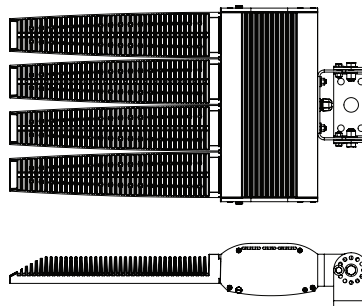

BLX-II - ELECTRICAL LOAD (A)							
Ordering Nomenclature	System Watts	120	208	240	277	347	480
BLX-II-3-96LD-3	99	0.82	0.47	0.41	0.36	0.28	0.21
BLX-II-3-96LD-5	152	1.27	0.73	0.63	0.55	0.44	0.32
BLX-II-3-96LD-7	204	1.70	0.98	0.85	0.74	0.59	0.42
BLX-II-3-96LD-10	314	2.62	1.51	1.31	1.14	0.91	0.66
BLX-II-3-96LD-12	362	3.02	1.74	1.51	1.31	1.04	0.75
BLX-II-4-128LD-3	132	1.10	0.63	0.55	0.47	0.38	0.27
BLX-II-4-128LD-5	203	1.69	0.98	0.85	0.73	0.58	0.42
BLX-II-4-128LD-7	272	2.27	1.31	1.13	0.98	0.78	0.57
BLX-II-4-128LD-10	419	3.49	2.02	1.75	1.51	1.21	0.87
BLX-II-4-128LD-12	483	4.03	2.32	2.01	1.74	1.39	1.01
BLX-II-6-192LD-3	197	1.64	0.95	0.82	0.71	0.57	0.41
BLX-II-6-192LD-5	304	2.53	1.46	1.27	1.10	0.88	0.63
BLX-II-6-192LD-7	408	3.40	1.96	1.70	1.47	1.17	0.85
BLX-II-6-192LD-10	629	5.24	3.02	2.62	2.27	1.81	1.31
BLX-II-6-192LD-12	725	6.04	3.48	3.02	2.62	2.09	1.51
BLX-II-8-256LD-3	263	2.19	1.26	1.10	0.95	0.76	0.55
BLX-II-8-256LD-5	406	3.38	1.95	1.69	1.46	1.17	0.84
BLX-II-8-256LD-7	544	4.53	2.61	2.26	1.96	1.57	1.13
BLX-II-8-256LD-10	838	6.99	4.03	3.49	3.03	2.42	1.75
BLX-II-8-256LD-12	966	8.05	4.64	4.02	3.49	2.78	2.01

BLX-II EPA Data				
Tilt Deg.	BLX-II-3	BLX-II-4	BLX-II-6	BLX-II-8
0	.7	.7	.8	1.1
10	.71	.91	.2	1.6
20	1.02	1.31	.8	2
30	1.32	1.72	.4	3.1
40	1.62	2.13		3.9
50	1.86	2.43	.4	4.5
Weight				
BLX-II	45 LBS	54 LBS	68 LBS	96 LBS

BLX Features

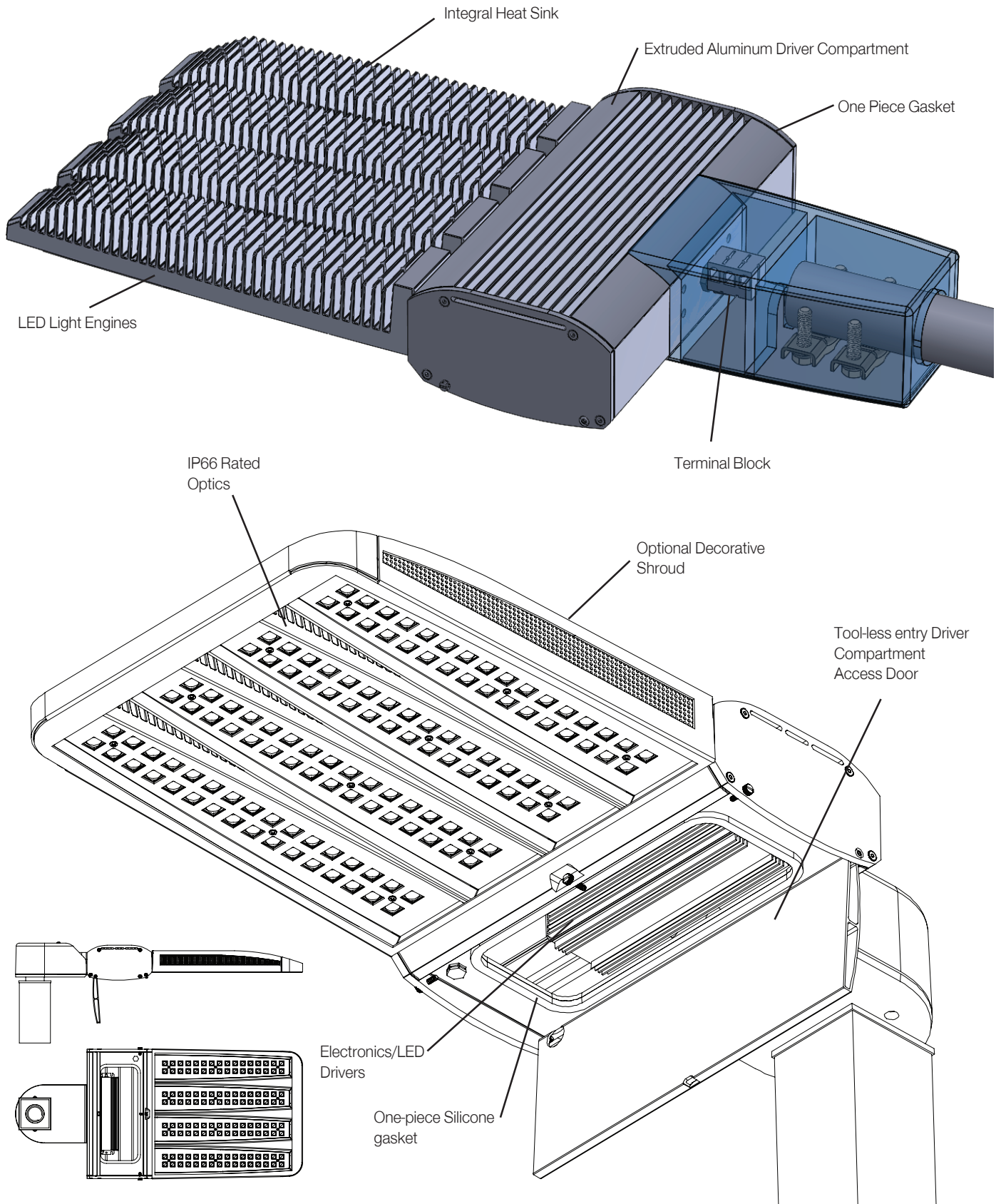

BLX-II Mounting Options

Post Top Mount

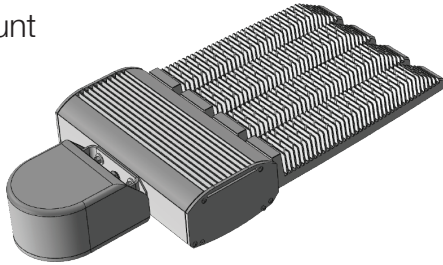

Post Top fits over a 2" - 2-3/8" tenon and is adjustable up to 45 degrees.

Mast Arm Mount

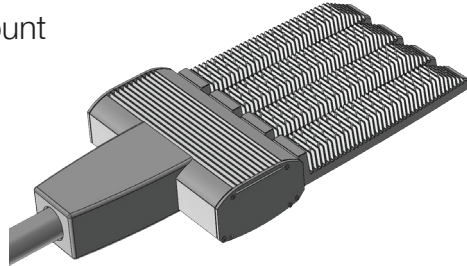

Mast Arm Fitter fits over a 2" - 2-3/8" tenon.

Knuckle Mount

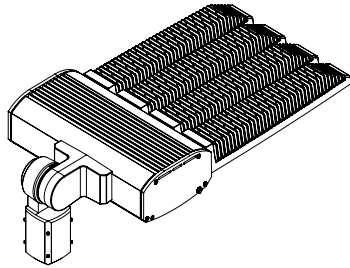

An adjustable knuckle slip fits over a 2-3/8" Tenon, and allows for up to 50 degrees of vertical adjustment in 10 degree increments from horizontal, as well as full side to side adjustment with the knuckle mount.

Bolt-On Arm Mount

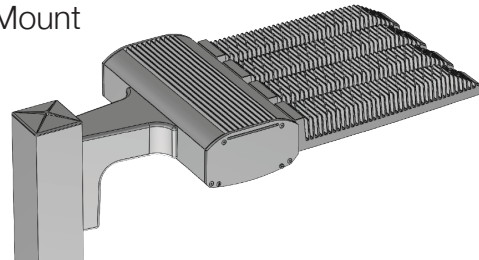

The Bolt -On Arm (BOA) utilizes a 2 piece cleat system for easy installation. A Round Pole Plate Adaptor (RPP) is required for mounting to round poles.

Trunnion Mount

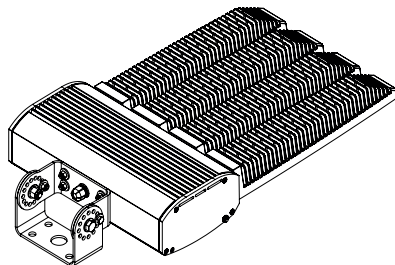

Trunnion Mount is adjustable up to 50 degrees.

Adjustable Wall Mount

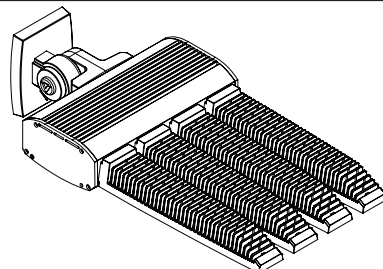

Adjustable Wall Mount allows for up to 50 degrees of vertical adjustment in 10-degree increments.

WATTSTOPPER PLUS

FSP-600 Series

The FSP-600 series by Wattstopper PLUS is an integrated luminaire level lighting controller and sensor for indoor/outdoor lighting applications that require networked wireless control. The FSP-600 is designed to integrate directly into exterior, high bay, parking garage, and general site lighting solutions. It is a passive infrared (PIR) sensor and closed loop photosensor.

The FSP-600 series design intends to reduce installer labor time and make on-site start up easy for technicians.

Once commissioned and paired to a Wattstopper PLUS network, the devices can measure both motion and daylight contribution in order to automatically switch or dim lighting. It also provides the ability to communicate to other fixtures in the space without any front-end devices.

The Wattstopper PLUS FSP-600 series is available in a few different options including: internal, external straight nipple, and external drop nipple. Sensor lens options sold separately and should be ordered based on designed mounting height and desired finish.

FSP-621



FSP-200 Series

The FSP-200 series sensors provide multi-level control based on motion and/or daylight contribution. They control 0-10 VDC LED drivers or dimming ballasts, as well as non-dimming ballasts and, with an FSP-Lx Lens, are rated for wet and cold locations. All control parameters are adjustable via a wireless configuration tool capable of storing and transmitting sensor profiles. The FSP-200 series is available in two different voltage configurations adding flexibility to your fixture design or project.

Typically, the sensor ramps lighting On to the selected High mode level when motion is detected and the ambient light level is below the hold off setpoint. After the sensor stops detecting movement and the time delay elapses, lights fade to the Low mode level. If there is no motion during the subsequent cut off time delay, the lights will turn Off. For dusk to dawn control, the integral photocell can switch the lights On and Off based on the ambient light level so that lighting remains on overnight even without motion detection.

Initial setup and subsequent sensor adjustments are made using a Wireless Handheld Configuration Tool (FSIR-100). This tool enables adjustment of parameters including high and low modes, sensitivity, time delay, cut off and more. The FSIR-100 is also used to initiate automatic calibration of the FSP-2x1B ambient light level setpoint. The setpoint is used to hold the controlled lighting off or at a low level when there is sufficient daylight. The wireless tool stores up to six sensor parameter profiles to speed configuration of multiple sensors.

FSP-211



FSP-221



Lens with Shroud Dimensions

The FSP-Lx-S models include a shroud, which blocks high-angle light coming from the fixture, to improve photocell performance. With the shroud attached, the dimensions for all three lenses are identical

FSP-L2-S and FSP-L3-S

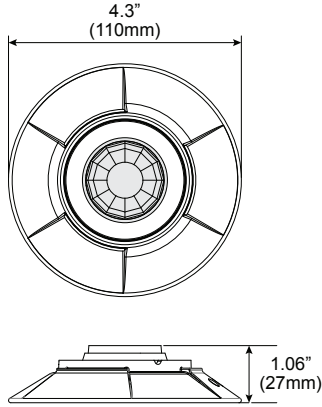

FSP-L7-S

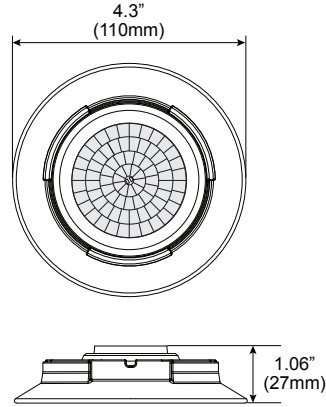

COVERAGE

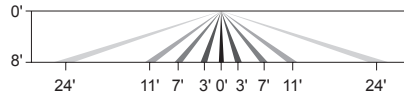
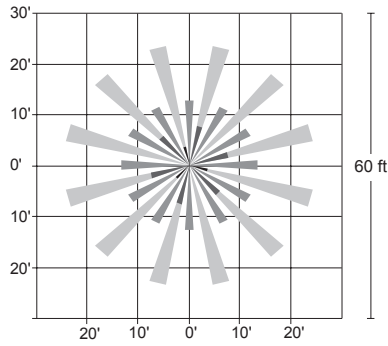

FSP-L2 top and side coverage patterns

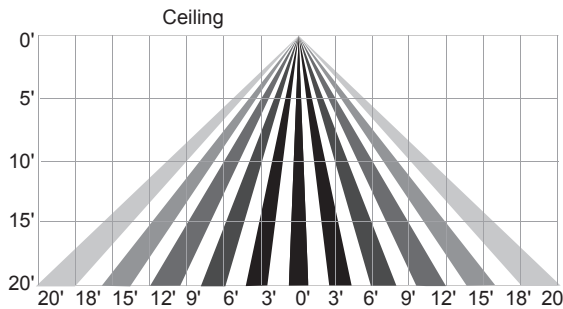
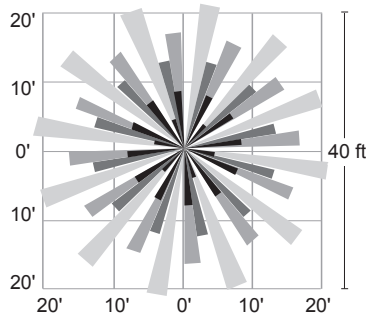

FSP-L3 top and side coverage patterns

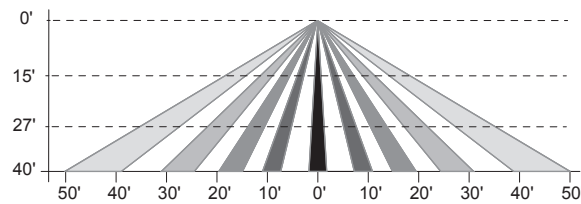
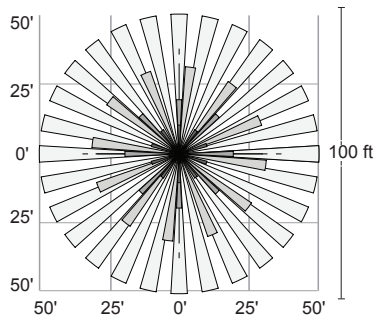

FSP-L7 top and side coverage patterns

BLX-II LED SPECIFICATIONS / Forward Optics																													
Led Count	Current & Watts	Distribution Type	70CRI																										
			27K				30K				35K				40K				50K										
			Lumens	B	U	G	LPW	Lumens	B	U	G	LPW	Lumens	B	U	G	LPW	Lumens	B	U	G	LPW							
96LD	350 mA (96.6W)	T1	14611	4	0	4	148	15246	4	0	4	155	15246	4	0	4	155	15087	4	0	4	153	15881	4	0	4	161		
		T2	14010	3	0	3	142	15229	3	0	3	154	15229	3	0	3	154	15148	3	0	3	154	15892	3	0	3	161		
		T3R	13656	3	0	3	139	14843	3	0	3	151	14843	3	0	3	151	14765	3	0	3	150	15490	3	0	3	157		
		T3	13484	2	0	2	137	14657	2	0	2	149	14657	2	0	2	149	14579	2	0	2	148	15296	2	0	2	155		
		T3W	13612	2	0	2	140	15013	2	0	2	152	15013	2	0	2	152	14934	2	0	2	151	15668	2	0	2	159		
		T3LG	13960	3	0	2	142	15173	3	0	3	154	15173	3	0	3	154	15043	3	0	3	153	15835	3	0	3	161		
		T4	13688	3	0	3	139	14878	3	0	3	151	14878	3	0	3	151	14799	3	0	3	150	15526	3	0	3	157		
		T4T	14579	2	0	2	148	15847	2	0	2	161	15847	2	0	2	161	15763	2	0	2	160	16538	2	0	2	168		
		T4LG	13980	3	0	2	142	15196	3	0	2	154	15196	3	0	2	154	15065	3	0	2	153	15858	3	0	2	161		
		T4FT	14754	2	0	3	150	15396	2	0	3	156	15396	2	0	3	156	15235	2	0	3	155	16037	2	0	3	163		
		T5	14401	4	0	2	146	15653	4	0	2	159	15653	4	0	2	159	15570	4	0	2	158	16335	4	0	2	166		
		T5W	14056	3	0	2	143	15278	4	0	2	155	15278	4	0	2	155	15147	4	0	2	154	15944	4	0	2	162		
		T5W	13246	4	0	3	134	14398	4	0	3	146	14398	4	0	3	146	14321	4	0	3	145	15025	4	0	3	152		
		T5WW	12639	4	0	3	128	13738	4	0	3	139	13738	4	0	3	139	13665	4	0	3	139	14337	4	0	3	145		
		FN	14368	4	0	1	146	15618	5	0	1	158	15618	5	0	1	158	15535	5	0	1	158	16298	5	0	1	165		
		FM	14586	4	0	1	148	15854	5	0	1	161	15854	5	0	1	161	15770	5	0	1	160	16545	5	0	1	168		
		FW	14978	3	0	1	152	15629	4	0	1	159	15629	4	0	1	159	15466	4	0	1	157	16280	4	0	1	165		
		96LD	530 mA (152.1W)	T1	22119	5	0	5	145	23080	5	0	5	152	23080	5	0	5	152	22840	5	0	5	150	24042	5	0	5	158
				T2	21210	3	0	4	139	23054	3	0	4	152	23054	3	0	4	152	22931	3	0	4	151	24059	4	0	4	158
				T3R	20673	3	0	4	136	22471	3	0	4	148	22471	3	0	4	148	22351	3	0	4	147	23450	3	0	4	154
T3	20413			3	0	3	134	22189	3	0	3	146	22189	3	0	3	146	22071	3	0	3	145	23156	3	0	3	152		
T3W	20910			3	0	3	137	22728	3	0	3	149	22728	3	0	3	149	22607	3	0	3	149	23719	3	0	3	156		
T3LG	21133			3	0	3	139	22970	3	0	3	151	22970	3	0	3	151	22773	3	0	3	150	23971	3	0	3	158		
T4	20721			3	0	3	136	22523	3	0	3	148	22523	3	0	3	148	22403	3	0	3	147	23504	3	0	3	155		
T4T	22071			3	0	2	145	23990	3	0	3	158	23990	3	0	3	158	23863	3	0	3	157	25036	3	0	3	165		
T4LG	21164			3	0	3	139	23004	3	0	3	151	23004	3	0	3	151	22806	3	0	3	150	24007	3	0	3	158		
T4FT	22336			3	0	4	147	23307	3	0	4	153	23307	3	0	4	153	23064	3	0	4	152	24278	3	0	4	160		
T5	21800			4	0	2	143	23696	4	0	2	156	23696	4	0	2	156	23570	4	0	2	155	24729	4	0	2	163		
T5LG	21278			4	0	2	140	23129	4	0	2	152	23129	4	0	2	152	22930	4	0	2	151	24136	4	0	2	159		
T5W	20052			4	0	3	132	21796	4	0	4	143	21796	4	0	4	143	21680	4	0	4	143	22746	4	0	4	150		
T5WW	19134			4	0	3	126	20798	4	0	3	137	20798	4	0	3	137	20687	4	0	3	136	21704	4	0	3	143		
FN	21751			5	0	1	143	23643	5	0	1	155	23643	5	0	1	155	23517	5	0	1	155	24673	5	0	1	162		
FM	22081			5	0	1	145	24001	5	0	1	158	24001	5	0	1	158	23874	5	0	1	157	25047	5	0	1	165		
FW	22674			4	0	1	149	23660	4	0	1	156	23660	4	0	1	156	23414	4	0	1	154	24646	4	0	1	162		
96LD	700 mA (203.8W)			T1	28660	5	0	5	141	29906	5	0	5	147	29906	5	0	5	147	29505	5	0	5	145	31152	5	0	5	153
				T2	27482	4	0	4	135	29872	4	0	4	147	29872	4	0	4	147	29713	4	0	4	146	31173	4	0	4	153
				T3R	26787	4	0	4	131	29116	4	0	4	143	29116	4	0	4	143	28961	4	0	4	142	30385	4	0	4	149
		T3	26450	3	0	3	130	28750	3	0	3	141	28750	3	0	3	141	28598	3	0	3	140	30003	3	0	3	147		
		T3W	27094	3	0	4	133	29450	3	0	4	144	29450	3	0	4	144	29293	3	0	4	144	30733	3	0	4	151		
		T3LG	27382	3	0	3	134	29763	4	0	3	146	29763	4	0	3	146	29507	4	0	3	145	31060	4	0	3	152		
		T4	26849	4	0	4	132	29184	4	0	4	143	29184	4	0	4	143	29029	4	0	4	142	30456	4	0	4	149		
		T4T	28598	3	0	3	140	31085	3	0	3	152	31085	3	0	3	152	30920	3	0	3	152	32440	3	0	3	159		
		T4LG	27423	3	0	3	135	29807	3	0	3	146	29807	3	0	3	146	29651	3	0	3	145	31106	3	0	3	153		
		T4FT	28941	3	0	4	142	30199	3	0	5	148	30199	3	0	5	148	29885	3	0	5	147	31458	3	0	5	154		
		T5	28247	5	0	3	139	30704	5	0	3	151	30704	5	0	3	151	30540	5	0	3	150	32042	5	0	3	157		
		T5LG	27571	4	0	2	135	29968	5	0	3	147	29968	5	0	3	147	29711	5	0	3	146	31274	5	0	3	153		
		T5W	25982	5	0	4	127	28242	5	0	4	139	28242	5	0	4	139	28091	5	0	4	138	29472	5	0	4	145		
		T5WW	24793	5	0	4	122	26949	5	0	4	132	26949	5	0	4	132	26805	5	0	4	131	28123	5	0	4	138		
		FN	28184	5	0	2	138	30635	5	0	2	150	30635	5	0	2	150	30472	5	0	2	149	31970	5	0	2	157		
		FM	28611	5	0	1	140	31099	5	0	1	153	31099	5	0	1	153	30934	5	0	1	152	32455	5	0	1	159		
		FW	29380	5	0	1	144	30657	5	0	1	150	30657	5	0	1	150	30338	5	0	1	149	31934	5	0	1	157		
		96LD	1050 mA (314.4W)	T1	40560	5	0	5	129	42323	5	0	5	135	42323	5	0	5	135	41883	5	0	5	133	44067	5	0	5	140
				T2	38893	4	0	5	124	42275	4	0	5	134	42275	4	0	5	134	42050	4	0	5	134	44117	4	0	5	140
				T3R	37909	4	0	5	121	41206	4	0	5	131	41206	4	0	5	131	40986	4	0	5	130	43001	4	0	5	137
T																													

BLX-II LED SPECIFICATIONS / Forward Optics																													
Led Count	Current & Watts	Distribution Type	70CRI																										
			27K				30K				35K				40K				50K										
			Lumens	B	U	G	LPW	Lumens	B	U	G	LPW	Lumens	B	U	G	LPW	Lumens	B	U	G	LPW							
128LD	350 mA (131.5W)	T1	19288	4	0	4	147	20127	4	0	4	153	20127	4	0	4	153	19917	4	0	4	152	20966	4	0	4	159		
		T2	18495	3	0	3	141	20104	3	0	3	153	20104	3	0	3	153	19997	3	0	3	152	20980	3	0	3	160		
		T3R	18028	3	0	3	137	19595	3	0	3	149	19595	3	0	3	149	19491	3	0	3	148	20449	3	0	3	156		
		T3	17801	3	0	3	135	19349	3	0	3	147	19349	3	0	3	147	19246	3	0	3	146	20192	3	0	3	154		
		T3W	18234	3	0	3	139	19620	3	0	3	151	19620	3	0	3	151	19714	3	0	3	150	20683	3	0	3	157		
		T3LG	18428	3	0	3	140	20031	3	0	3	152	20031	3	0	3	152	19859	3	0	3	151	20904	3	0	3	159		
		T4	18070	3	0	3	137	19641	3	0	3	149	19641	3	0	3	149	19536	3	0	3	149	20497	3	0	3	156		
		T4T	19247	3	0	2	146	20920	3	0	2	159	20920	3	0	2	159	20809	3	0	2	158	21832	3	0	2	166		
		T4LG	18456	3	0	2	140	20060	3	0	2	153	20060	3	0	2	153	19888	3	0	2	151	20335	3	0	2	159		
		T4FT	19478	3	0	3	148	20324	3	0	4	155	20324	3	0	4	155	20113	3	0	4	153	21171	3	0	4	161		
		T5	19011	4	0	2	145	20664	4	0	2	157	20664	4	0	2	157	20554	4	0	2	156	21564	4	0	2	164		
		T5LG	18555	4	0	2	141	20169	4	0	2	153	20169	4	0	2	153	19995	4	0	2	152	21048	4	0	2	160		
		T5W	17486	4	0	3	133	19007	4	0	3	145	19007	4	0	3	145	18906	4	0	3	144	19835	4	0	3	151		
		T5WW	16886	4	0	3	127	18137	4	0	3	138	18137	4	0	3	138	18040	4	0	3	137	18927	4	0	3	144		
		FN	18968	5	0	1	144	20617	5	0	1	157	20617	5	0	1	157	20508	5	0	1	156	21516	5	0	1	164		
		FM	19256	5	0	1	146	20930	5	0	1	159	20930	5	0	1	159	20819	5	0	1	158	21842	5	0	1	166		
		FW	19773	4	0	1	150	20632	4	0	1	157	20632	4	0	1	157	20417	4	0	1	155	21492	4	0	1	163		
		128LD	530 mA (202.8W)	T1	29200	5	0	5	144	30469	5	0	5	150	30469	5	0	5	150	30152	5	0	5	149	31739	5	0	5	157
				T2	27999	4	0	4	138	30434	4	0	4	150	30434	4	0	4	150	30272	4	0	4	149	31760	4	0	5	157
				T3R	27291	4	0	4	135	29664	4	0	4	146	29664	4	0	4	146	29507	4	0	4	146	30957	4	0	5	153
T3	26948			3	0	3	133	29292	3	0	4	144	29292	3	0	4	144	29136	3	0	4	144	30568	3	0	4	151		
T3W	27604			3	0	4	136	30004	3	0	4	148	30004	3	0	4	148	29845	3	0	4	147	31312	3	0	4	154		
T3LG	27898			4	0	3	138	30324	4	0	3	150	30324	4	0	3	150	30063	4	0	3	148	31645	4	0	4	156		
T4	27355			4	0	4	135	29733	4	0	4	147	29733	4	0	4	147	29575	4	0	4	146	31029	4	0	4	153		
T4T	29137			3	0	3	144	31671	3	0	3	156	31671	3	0	3	156	31502	3	0	3	155	33051	3	0	3	163		
T4LG	27939			3	0	3	139	30369	3	0	3	150	30369	3	0	3	150	30107	3	0	3	148	31692	3	0	3	156		
T4FT	29486			3	0	4	145	30768	3	0	5	152	30768	3	0	5	152	30448	3	0	5	150	32050	3	0	5	158		
T5	28779			5	0	3	142	31282	5	0	3	154	31282	5	0	3	154	31115	5	0	3	153	32645	5	0	3	161		
T5LG	28090			4	0	3	139	30533	5	0	3	151	30533	5	0	3	151	30270	5	0	3	149	31863	5	0	3	157		
T5W	26471			5	0	4	131	28773	5	0	4	142	28773	5	0	4	142	28620	5	0	4	141	30027	5	0	4	148		
T5WW	25260			5	0	4	125	27456	5	0	4	135	27456	5	0	4	135	27310	5	0	4	135	28653	5	0	4	141		
FN	28715			5	0	2	142	31212	5	0	2	154	31212	5	0	2	154	31046	5	0	2	153	32572	5	0	2	161		
FM	29150			5	0	1	144	31685	5	0	2	156	31685	5	0	2	156	31516	5	0	2	155	33066	5	0	2	163		
FW	29333			5	0	1	148	31234	5	0	1	154	31234	5	0	1	154	30909	5	0	1	152	32536	5	0	1	160		
128LD	700 mA (271.8W)			T1	37835	5	0	5	139	39480	5	0	5	145	39480	5	0	5	145	39069	5	0	5	144	41125	5	0	5	151
				T2	36280	4	0	5	139	39434	4	0	5	145	39434	4	0	5	145	39225	4	0	5	144	41153	4	0	5	151
				T3R	35362	4	0	5	130	38437	4	0	5	141	38437	4	0	5	141	38233	4	0	5	141	40112	4	0	5	148
		T3	34918	3	0	4	128	37954	3	0	4	140	37954	3	0	4	140	37753	3	0	4	139	39608	3	0	4	146		
		T3W	35767	3	0	4	132	38877	3	0	4	143	38877	3	0	4	143	38671	3	0	4	142	40572	3	0	5	149		
		T3LG	36148	4	0	4	133	39292	4	0	4	145	39292	4	0	4	145	38954	4	0	4	143	41004	4	0	4	151		
		T4	35444	4	0	4	130	38526	4	0	5	142	38526	4	0	5	142	38321	4	0	5	141	42005	4	0	5	148		
		T4T	37754	3	0	3	139	41037	4	0	3	151	41037	4	0	3	151	40818	4	0	3	150	42825	4	0	3	158		
		T4LG	36202	4	0	4	133	39350	4	0	4	145	39350	4	0	4	145	39011	4	0	4	144	41064	4	0	4	151		
		T4FT	38206	3	0	5	141	39867	4	0	5	147	39867	4	0	5	147	39452	4	0	5	145	41528	4	0	5	153		
		T5	37290	5	0	4	137	40533	5	0	4	149	40533	5	0	4	149	40317	5	0	4	148	42299	5	0	4	156		
		T5LG	36397	5	0	3	134	39562	5	0	3	146	39562	5	0	3	146	39222	5	0	3	144	41286	5	0	3	152		
		T5W	34300	5	0	5	126	37283	5	0	5	137	37283	5	0	5	137	37084	5	0	5	136	38907	5	0	5	143		
		T5WW	32730	5	0	5	120	35576	5	0	5	131	35576	5	0	5	131	35396	5	0	5	130	37126	5	0	5	137		
		FN	37207	5	0	2	137	40442	5	0	2	149	40442	5	0	2	149	40227	5	0	2	148	42204	5	0	2	155		
		FM	37771	5	0	2	139	41055	5	0	2	151	41055	5	0	2	151	40837	5	0	2	150	42844	5	0	2	158		
		FW	38785	5	0	2	143	40471	5	0	2	149	40471	5	0	2	149	40050	5	0	2	147	42158	5	0	2	155		
		128LD	1050 mA (419.2W)	T1	53444	5	0	5	128	55873	5	0	5	133	55873	5	0	5	133	55291	5	0	5	132	58201	5	0	5	139
				T2	51343	5	0	5	122	55808	5	0	5	133	55808	5	0	5	133	55511	5	0	5	132	58240	5	0	5	139
				T3R	50045	4	0	5	119	54397	5	0	5	130	54397	5	0	5	130	54108	5	0	5	129	56767	5	0	5	135

BLX-II LED SPECIFICATIONS / Forward Optics																													
Led Count	Current & Watts	Distribution Type	70CRI																										
			27K				30K				35K				40K				50K										
			Lumens	B	U	G	LPW	Lumens	B	U	G	LPW	Lumens	B	U	G	LPW	Lumens	B	U	G	LPW	Lumens	B	U	G	LPW		
192LD	350 mA (197.2W)	T1	28354	5	0	5	144	29687	5	0	5	150	29687	5	0	5	150	29278	5	0	5	148	30819	5	0	5	156		
		T2	27188	4	0	4	138	29553	4	0	4	150	29553	4	0	4	150	29395	4	0	4	149	30840	4	0	4	156		
		T3R	26501	4	0	4	134	28805	4	0	4	146	28805	4	0	4	146	28652	4	0	4	145	30060	4	0	4	152		
		T3	26168	3	0	3	133	28443	3	0	3	144	28443	3	0	3	144	28292	3	0	3	143	29683	3	0	3	151		
		T3W	26804	3	0	4	136	29135	3	0	4	148	29135	3	0	4	148	28980	3	0	4	147	30405	3	0	4	154		
		T3LG	27090	3	0	3	137	29445	4	0	3	149	29445	4	0	3	149	29192	4	0	3	148	30729	4	0	4	156		
		T4	26562	4	0	4	135	28872	4	0	4	146	28872	4	0	4	146	28718	4	0	4	146	30190	4	0	4	153		
		T4T	28293	3	0	3	143	30753	3	0	3	156	30753	3	0	3	156	30590	3	0	3	155	32093	3	0	3	163		
		T4LG	27130	3	0	3	138	29489	3	0	3	150	29489	3	0	3	150	29235	3	0	3	148	30774	3	0	3	156		
		T4FT	28632	3	0	4	145	29877	3	0	5	152	29877	3	0	5	152	29666	3	0	4	150	31122	3	0	5	158		
		T5	27946	5	0	3	142	30376	5	0	3	154	30376	5	0	3	154	30214	5	0	3	153	31699	5	0	3	161		
		T5LG	27276	4	0	2	138	29648	5	0	3	150	29648	5	0	3	150	29393	4	0	3	149	30940	5	0	3	157		
		T5W	25705	5	0	4	130	27940	5	0	4	142	27940	5	0	4	142	27791	5	0	4	141	29157	5	0	4	148		
		T5WW	24528	5	0	4	124	26661	5	0	4	135	26661	5	0	4	135	26519	5	0	4	134	27823	5	0	4	141		
		FN	27883	5	0	2	141	30308	5	0	2	154	30308	5	0	2	154	30146	5	0	2	153	31628	5	0	2	160		
		FM	28306	5	0	1	144	30767	5	0	1	156	30767	5	0	1	156	30603	5	0	1	155	32108	5	0	2	163		
		FW	29066	5	0	1	147	30330	5	0	1	154	30330	5	0	1	154	30014	5	0	1	152	31593	5	0	1	160		
		192LD	530 mA (304.1W)	T1	42924	5	0	5	141	44790	5	0	5	147	44790	5	0	5	147	44323	5	0	5	146	46656	5	0	5	153
				T2	41159	4	0	5	135	44738	4	0	5	147	44738	4	0	5	147	44500	4	0	5	146	46688	4	0	5	154
				T3R	40118	4	0	5	132	43607	4	0	5	143	43607	4	0	5	143	43375	4	0	5	143	45507	4	0	5	150
T3	39614			3	0	4	130	43059	4	0	4	142	43059	4	0	4	142	42830	4	0	4	141	44935	4	0	5	148		
T3W	40578			3	0	5	133	44106	4	0	5	145	44106	4	0	5	145	43872	4	0	5	144	46028	4	0	5	151		
T3LG	41010			4	0	4	135	44576	4	0	4	147	44576	4	0	4	147	44193	4	0	4	145	46519	4	0	4	153		
T4	40211			4	0	5	132	43708	4	0	5	144	43708	4	0	5	144	43475	4	0	5	143	45613	4	0	5	150		
T4T	42831			4	0	3	141	46556	4	0	3	153	46556	4	0	3	153	46308	4	0	3	152	48585	4	0	3	160		
T4LG	41071			4	0	4	135	44642	4	0	4	147	44642	4	0	4	147	44258	4	0	4	146	46587	4	0	4	153		
T4FT	43345			4	0	5	143	45229	4	0	5	149	45229	4	0	5	149	44758	4	0	5	147	47114	4	0	5	155		
T5	42305			5	0	4	139	45984	5	0	4	151	45984	5	0	4	151	45740	5	0	4	150	47988	5	0	4	158		
T5LG	41292			5	0	3	136	44883	5	0	4	148	44883	5	0	4	148	44497	5	0	4	146	46839	5	0	4	154		
T5W	38913			5	0	5	128	42297	5	0	5	139	42297	5	0	5	139	42072	5	0	5	138	44140	5	0	5	145		
T5WW	37132			5	0	5	122	40360	5	0	5	133	40360	5	0	5	133	40146	5	0	5	132	42119	5	0	5	138		
FN	42211			5	0	2	139	45881	5	0	2	151	45881	5	0	2	151	45637	5	0	2	150	47881	5	0	2	157		
FM	42851			5	0	2	141	46577	5	0	2	153	46577	5	0	2	153	46329	5	0	2	152	48607	5	0	2	160		
FW	44001			5	0	2	145	45914	5	0	2	151	45914	5	0	2	151	45436	5	0	2	149	47828	5	0	2	157		
192LD	700 mA (407.7W)			T1	55617	5	0	5	136	58036	5	0	5	142	58036	5	0	5	142	57431	5	0	5	141	60454	5	0	5	148
				T2	53331	5	0	5	131	57969	5	0	5	142	57969	5	0	5	142	57660	5	0	5	141	60495	5	0	5	148
				T3R	51983	5	0	5	128	56503	5	0	5	139	56503	5	0	5	139	56202	5	0	5	138	58965	5	0	5	145
		T3	51330	4	0	5	126	55793	4	0	5	137	55793	4	0	5	137	55496	4	0	5	136	58224	4	0	5	143		
		T3W	52578	4	0	5	129	57150	4	0	5	140	57150	4	0	5	140	56846	4	0	5	139	59640	4	0	5	146		
		T3LG	53138	5	0	5	130	57759	5	0	5	142	57759	5	0	5	142	57262	5	0	5	140	60276	5	0	5	148		
		T4	52103	4	0	5	128	56634	5	0	5	139	56634	5	0	5	139	56333	5	0	5	138	59102	5	0	5	145		
		T4T	55498	4	0	4	136	60324	4	0	4	148	60324	4	0	4	148	60003	4	0	4	147	62953	4	0	4	154		
		T4LG	53216	4	0	4	131	57844	5	0	5	142	57844	5	0	5	142	57347	5	0	5	141	60365	5	0	5	148		
		T4FT	56163	4	0	5	138	58605	4	0	5	144	58605	4	0	5	144	57994	4	0	5	142	61047	4	0	5	150		
		T5	54817	5	0	4	134	59583	5	0	5	146	59583	5	0	5	146	59266	5	0	5	145	62180	5	0	5	153		
		T5LG	53504	5	0	4	131	58156	5	0	4	143	58156	5	0	4	143	57656	5	0	4	141	60691	5	0	4	149		
		T5W	50421	5	0	5	124	54805	5	0	5	134	54805	5	0	5	134	54514	5	0	5	134	57194	5	0	5	140		
		T5WW	48113	5	0	5	118	52296	5	0	5	128	52296	5	0	5	128	52018	5	0	5	128	54575	5	0	5	134		
		FN	54894	5	0	2	134	59450	5	0	3	146	59450	5	0	3	146	59134	5	0	3	145	62041	5	0	3	152		
		FM	55523	5	0	2	136	60351	5	0	2	148	60351	5	0	2	148	60030	5	0	2	147	62981	5	0	2	154		
		FW	57014	5	0	2	140	59493	5	0	2	146	59493	5	0	2	146	58873	5	0	2	144	61972	5	0	2	152		
		192LD	1050 mA (628.8W)	T1	78710	5	0	5	125	82133	5	0	5	131	82133	5	0	5	131	81277	5	0	5	129	85555	5	0	5	136
				T2	75475	5	0	5	120	82038	5	0	5	130	82038	5	0	5	130	81602	5	0	5	130	85613	5	0	5	136
				T3R	73566	5	0	5	117	79963	5	0	5	127	79963	5	0	5	127	79538	5	0	5	126	83448				

BLX-II LED SPECIFICATIONS / Forward Optics																													
Led Count	Current & Watts	Distribution Type	70CRI																										
			27K				30K				35K				40K				50K										
			Lumens	B	U	G	LPW	Lumens	B	U	G	LPW	Lumens	B	U	G	LPW	Lumens	B	U	G	LPW							
256LD	350 mA (262.9W)	T1	37034	5	0	5	141	38644	5	0	5	147	38644	5	0	5	147	38241	5	0	5	145	40254	5	0	5	153		
		T2	35511	4	0	5	135	38599	4	0	5	147	38599	4	0	5	147	38394	4	0	5	146	40281	4	0	5	153		
		T3R	34613	4	0	5	132	37623	4	0	5	143	37623	4	0	5	143	37423	4	0	5	142	39263	4	0	5	149		
		T3	34178	3	0	4	130	37150	3	0	4	141	37150	3	0	4	141	36953	3	0	4	141	38769	3	0	4	147		
		T3W	35010	3	0	4	133	38054	3	0	4	145	38054	3	0	4	145	37851	3	0	4	144	39712	3	0	4	151		
		T3LG	35383	4	0	4	135	38459	4	0	4	146	38459	4	0	4	146	38129	4	0	4	145	40135	4	0	4	153		
		T4	34693	4	0	4	132	37710	4	0	5	143	37710	4	0	5	143	37510	4	0	5	143	39354	4	0	5	150		
		T4T	36954	3	0	3	141	40167	4	0	3	153	40167	4	0	3	153	39954	4	0	3	152	41918	4	0	3	159		
		T4LG	35435	4	0	4	135	38516	4	0	4	146	38516	4	0	4	146	38185	4	0	4	145	40195	4	0	4	153		
		T4FT	37397	3	0	5	142	39023	3	0	5	148	39023	3	0	5	148	38616	3	0	5	147	40649	4	0	5	155		
		T5	36500	5	0	3	139	39674	5	0	4	151	39674	5	0	4	151	39463	5	0	4	150	41403	5	0	4	157		
		T5LG	35626	5	0	3	135	38724	5	0	3	147	38724	5	0	3	147	38391	5	0	3	146	40412	5	0	3	154		
		T5W	33573	5	0	5	128	36493	5	0	5	139	36493	5	0	5	139	36299	5	0	5	138	38083	5	0	5	145		
		T5WW	32036	5	0	4	122	34822	5	0	5	132	34822	5	0	5	132	34637	5	0	5	132	36340	5	0	5	138		
		FN	36419	5	0	2	139	39585	5	0	2	151	39585	5	0	2	151	39375	5	0	2	150	41310	5	0	2	157		
		FM	36971	5	0	2	141	40186	5	0	2	153	40186	5	0	2	153	39972	5	0	2	152	41937	5	0	2	159		
		FW	37963	5	0	2	144	39614	5	0	2	151	39614	5	0	2	151	39201	5	0	2	149	41265	5	0	2	157		
		256LD	530 mA (405.5W)	T1	56063	5	0	5	138	58501	5	0	5	144	58501	5	0	5	144	57892	5	0	5	143	60938	5	0	5	150
				T2	53759	5	0	5	133	58433	5	0	5	144	58433	5	0	5	144	58123	5	0	5	143	60980	5	0	5	150
				T3R	52399	5	0	5	129	56956	5	0	5	140	56956	5	0	5	140	56653	5	0	5	140	59438	5	0	5	147
T3	51741			4	0	5	128	56240	4	0	5	139	56240	4	0	5	139	55941	4	0	5	138	58691	4	0	5	145		
T3W	52999			4	0	5	131	57608	4	0	5	142	57608	4	0	5	142	57302	4	0	5	141	60118	4	0	5	148		
T3LG	53654			5	0	5	132	58222	5	0	5	144	58222	5	0	5	144	57721	5	0	5	142	60759	5	0	5	150		
T4	52521			4	0	5	130	57088	5	0	5	141	57088	5	0	5	141	56784	5	0	5	140	59576	5	0	5	147		
T4T	55943			4	0	4	138	60807	4	0	4	150	60807	4	0	4	150	60484	4	0	4	149	63457	4	0	4	156		
T4LG	53643			4	0	4	132	58308	5	0	5	144	58308	5	0	5	144	57906	5	0	5	143	60949	5	0	5	150		
T4FT	56613			4	0	5	140	59075	4	0	5	146	59075	4	0	5	146	58459	4	0	5	144	61536	4	0	5	152		
T5	55256			5	0	4	136	60061	5	0	5	148	60061	5	0	5	148	59742	5	0	5	147	62678	5	0	5	155		
T5LG	53933			5	0	4	133	58623	5	0	4	145	58623	5	0	4	145	58119	5	0	4	143	61178	5	0	4	151		
T5W	50825			5	0	5	125	55245	5	0	5	136	55245	5	0	5	136	54951	5	0	5	136	57652	5	0	5	142		
T5WW	48498			5	0	5	120	52716	5	0	5	130	52716	5	0	5	130	52435	5	0	5	129	55013	5	0	5	136		
FN	55132			5	0	3	136	59926	5	0	3	148	59926	5	0	3	148	59608	5	0	3	147	62538	5	0	3	154		
FM	55968			5	0	2	138	60835	5	0	2	150	60835	5	0	2	150	60511	5	0	2	149	63486	5	0	2	157		
FW	57471			5	0	2	142	59970	5	0	2	148	59970	5	0	2	148	59345	5	0	2	146	62469	5	0	2	154		
256LD	700 mA (543.5W)			T1	72643	5	0	5	134	75802	5	0	5	139	75802	5	0	5	139	75012	5	0	5	138	78960	5	0	5	145
				T2	69657	5	0	5	128	75714	5	0	5	139	75714	5	0	5	139	75312	5	0	5	139	79014	5	0	5	145
				T3R	67896	5	0	5	125	73800	5	0	5	136	73800	5	0	5	136	73407	5	0	5	135	77016	5	0	5	142
		T3	67043	4	0	5	123	72872	5	0	5	134	72872	5	0	5	134	72485	5	0	5	133	76048	5	0	5	140		
		T3W	68673	4	0	5	126	74645	4	0	5	137	74645	4	0	5	137	74248	4	0	5	137	77898	5	0	5	143		
		T3LG	69405	5	0	5	128	75440	5	0	5	139	75440	5	0	5	139	74791	5	0	5	138	78728	5	0	5	145		
		T4	68053	5	0	5	125	73971	5	0	5	136	73971	5	0	5	136	73577	5	0	5	135	77194	5	0	5	142		
		T4T	72487	5	0	4	133	78790	5	0	4	145	78790	5	0	4	145	78371	5	0	4	144	82224	5	0	4	151		
		T4LG	69507	5	0	5	128	75551	5	0	5	139	75551	5	0	5	139	74902	5	0	5	138	78844	5	0	5	145		
		T4FT	73356	4	0	5	135	76545	5	0	5	141	76545	5	0	5	141	75748	5	0	5	139	79734	5	0	5	147		
		T5	71597	5	0	5	132	77823	5	0	5	143	77823	5	0	5	143	77409	5	0	5	142	81215	5	0	5	149		
		T5LG	69883	5	0	5	129	75959	5	0	5	140	75959	5	0	5	140	75306	5	0	5	139	79270	5	0	5	146		
		T5W	65856	5	0	5	121	71582	5	0	5	132	71582	5	0	5	132	71202	5	0	5	131	74702	5	0	5	137		
		T5WW	62841	5	0	5	116	68305	5	0	5	126	68305	5	0	5	126	67942	5	0	5	125	71282	5	0	5	131		
		FN	71437	5	0	3	131	77649	5	0	3	143	77649	5	0	3	143	77236	5	0	3	142	81033	5	0	3	149		
		FM	72520	5	0	3	133	78826	5	0	3	145	78826	5	0	3	145	78407	5	0	3	144	82261	5	0	3	151		
		FW	74467	5	0	2	137	77705	5	0	3	143	77705	5	0	3	143	76896	5	0	3	141	80943	5	0	3	149		
		256LD	1050 mA (838.3W)	T1	102805	5	0	5	123	107275	5	0	5	128	107275	5	0	5	128	106158	5	0	5	127	111745	5	0	5	133
				T2	98679	5	0	5	118	107152	5	0	5	128	107152	5	0	5	128	106582	5	0	5	127	111821	5	0	5	133
				T3R	96087	5	0	5	115	104442	5	0	5	125	104442	5	0	5	125	103886	5	0	5	124	108993	5	0	5	130
T3	94879			5	0	5	113	103130	5	0	5	123	103130	5	0	5	123	102581	5	0	5	122	107624	5	0	5	128		
T3W	97187			5	0	5	116	105638	5	0	5	126	105638	5	0	5	126	105076	5	0	5	125	110241	5	0	5	131		
T3LG	98222			5	0	5	117	106764	5	0	5	127	106764	5	0	5	127	105845	5	0	5	126	111416	5	0	5	133		
T4	96309			5	0	5	115	104684	5	0	5	125	104684	5	0	5	125	104127	5	0	5	124	109246	5	0	5	130		
T4T	102584			5	0	5	122	111505	5	0	5	133	111505	5	0	5	133	110912	5	0	5	132	116364	5	0	5	139		
T4LG	98367			5	0	5	117	106921	5	0	5	128	106921	5	0	5	128	106002	5	0	5	126	111581	5	0	5	133		
T4FT	103814			5	0	5	124	108327	5	0	5	129	108327	5	0	5	129	107199	5	0									