

ODEN LED Specifications

Architectural - Area - Site - Outdoor



This architectural fixture is highly versatile and can fit into any lighting need. It boasts a classic bell shape and design cues from the West Mission era, making it a stylish option for any design-oriented project.

With six interchangeable caps and shade styles, the Oden offers endless possibilities for customization. Architects, designers, and engineers can create a custom fixture that fits their unique application perfectly.

Sixteen optical distribution patterns are available. Select from 2700K, 3000K, 3500K, 4000K, or 5000K color temperatures and 70, 80, or 90 CRI options to achieve the perfect balance of visual comfort and design intent.

The Oden is constructed of high-quality, durable alloy aluminum that makes it weather-resistant and an ideal fixture for any lighting need.

Project Name:

Catalog Number:

Type:

Date:

Location:

Visionaire Lighting products are engineered with field serviceability and environmental responsibility at the core, giving customers a smarter, longer-lasting lighting solution. Designed for efficient maintenance and simplified access to key components, our fixtures help reduce downtime, extend product life, and make in-field updates or repairs faster and more cost-effective.



MODEL	OPTICS		LEDs	CURRENT	KELVIN
ODN-1-L	T1 Type 1	T5 Type 5	16LD	3 350mA	27K7 27K8 27K9 2700K 70, 80, & 90 CRI
	T2 Type 2	T5W Type 5 Wide	32LD	5 530mA	30K7 30K8 30K9 3000K 70, 80, & 90 CRI
	T3 Type 3	T5WW Type 5	48LD	7 700mA	35K7 35K8 35K9 3500K 70, 80, & 90 CRI
ODN-2-L	T3R Type 3 Round	Extra Wide	48LD		40K7 40K8 40K9 4000K 70, 80, & 90 CRI
	T3W Type 3 Wide	T5LG Type 5 Low Glare	64LD		50K7 50K8 50K9 5000K 70, 80, & 90 CRI
	T3LG Type 3 Low Glare	FN Flood Narrow	80LD		
	T4A Type 4	FM Flood Medium	96LD		
ODN-3-L	Automotive	FW Flood Wide	96LD		
	T4 Type 4		128LD		
	T4LG Type 4 Low Glare				

VOLTAGE	MOUNTING	FINISH	CAP/SHADE	CONTROL OPTIONS	SHIELD OPTIONS
UNV 120-277V	UAM1 Arm Mount *Decorative Arm not included. See decorative Arm section for Arm Mount options ODN-1 uses small arm. ODN-2 & ODN-3 uses large arm	BZ Bronze	C1	PC-120 PC-208 PC-240 PC-277 Button Type Photocell	CLS Cutoff Louver Shield
8 347V		BK Black	C2	DIM 0-10v Dimming Driver No Controls	
5 480V	YM Yoke Mount *Slips over 3"ØD tenon x 4" tall with special threaded mounting plate.	SBK Smooth Black	C3	DTO Dim to Off Driver	OPTIONS
	MAP-01 Mast Arm Fitter *Designed to slip over 2-3/8" O.D. mast arm.	WH White	C4	D4i 4Di DALI Driver	
	MAP-02 Mast Arm Fitter *Designed to slip over 2-3/8" O.D. mast arm. Includes provision only for twist lock receptacle. Receptacle and shorting cap, to be ordered separately under options.	SWH Smooth White	C5	Z10 or Z18 Zhaga 4 Pin Receptacle	IR-R Illuminated Rings Red
		GP Graphite	C6	VWC Visionaire Wireless Control	IR-B Illuminated Rings Blue
		GY Grey	H1	WSP6-L2 WSP6-L3 WSP6-L7 8' Mounting Height 9-20' Mounting Height 21-40' Mounting Height	IR-G Illuminated Rings Green
		SL Silver Metallic	H2	WSC-8 WSC-20 WSC-40 8' Mounting Height 9-20' Mounting Height 21-40' Mounting Height	BAA Buy America(n) Act Compliant
		CC Custom Color	H3	*The WSC option will require (1) FSIR 100 remote for programming	BABA Build America Buy American
			H4		
			H5		
			H6		

Housing

High-quality, one-piece spun aluminum shade and durable cast aluminum top cap; available in three housing sizes.

- All external hardware is stainless steel.
- Aluminum removable door assembly.

Thermal Management

The Oden - LED provides excellent overall thermal management by maximizing the efficiency of the heat sink in the fixture. This enables the Oden - LED to withstand higher ambient temperatures and higher drive currents without degrading LED life.

Optical System

The highest lumen output LEDs are utilized. Available with up to 128 LED. The optical system qualifies as IES full cutoff to restrict light trespass, glare and light pollution for neighborhood-friendly lighting.

- L70 life of our LEDs is rated over 100,000 hours (for 700 mA).
- Available with 16 IES distribution patterns.
- CRI values are 70, 80 or 90.
- CCT values are 2700K, 3000K, 3500K, 4000K, 5000K

Quali-Guard® Finish

Fixture components are chemically pretreated through a multiple-stage washer and finished with an electrostatically-applied, thermoset polyester powder coat textured paint with a 3 to 5 mils thickness. Finish is oven-baked at 400 °F for maximum adherence and finish hardness.

- Available in standard and custom colors.

Mounting

The Oden - LED mounts to a wide selection of decorative and custom Visionaire mounting arms. Visionaire decorative mounting arm required. See Visionaire Mounting Arms section of catalog.

Electrical Assembly

The Oden - LED is supplied with a high-performance LED driver, located in its cap, that accepts 120 V thru 277 V, and 480 V, 50 Hz to 60 Hz input. Power factor is 90%.

- Rated for operation from -40°C to +55°C.
- 10 kV surge protector supplied as standard.

Warranty

- Five (5) year Limited Warranty on electrical components.
- Five (5) year Warranty on finish.

For full warranty information, please visit www.visionairelighting.com

Options

- Wattstopper Plus
- Wattstopper FSP-211 Motion Sensor/Control
- Dimming Driver
- Dim To Off Driver
- Button Type Photocell
- D4i DALI Driver
- Zhaga 4 Pin Receptacle
- Visionaire Wireless Control
- Cutoff louver system
- Illuminated Rings
- BAA / BABA

Listings

- Oden is cUL listed, suitable for wet locations.
- IP65 Rated
- IDA Certification
- LM79
- LM80



3000K or lower must be selected for IDA certification.
Fixed mount must be selected for IDA dark sky certification.

Light Color

Correlated Color Temperature (CCT)



Photometric Optical Summary

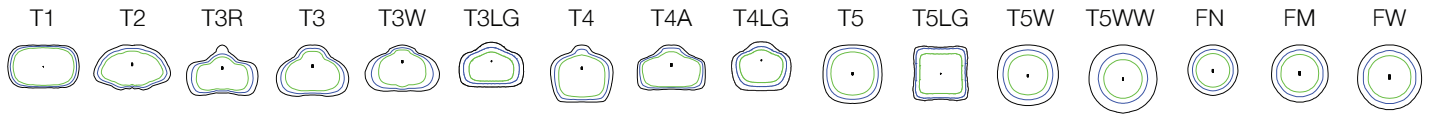

EPA Data

Fixture	Fixture Only	Fixture with VA110-S1	2 Fixtures with VA110-D2	Fixture with VA107-S1	2 Fixtures with VA107-D2
ODN-1	1.2	2.2	4.1	3.5	5.6
ODN-2	2.6	3.6	6.6	4.9	8.3
ODN-3	3.5	4.5	8.6	5.8	9.8

Dimensions

Size 1

Width: ODN-1 20"

Height: ODN-1 19.5"

Weight: 40 LBS

Size 2

Width: ODN-2 25"

Height: ODN-2 22.5"

Weight: 53 LBS

Size 3

Width: ODN-3 30"

Height: ODN-3 24"

Weight: 74 LBS

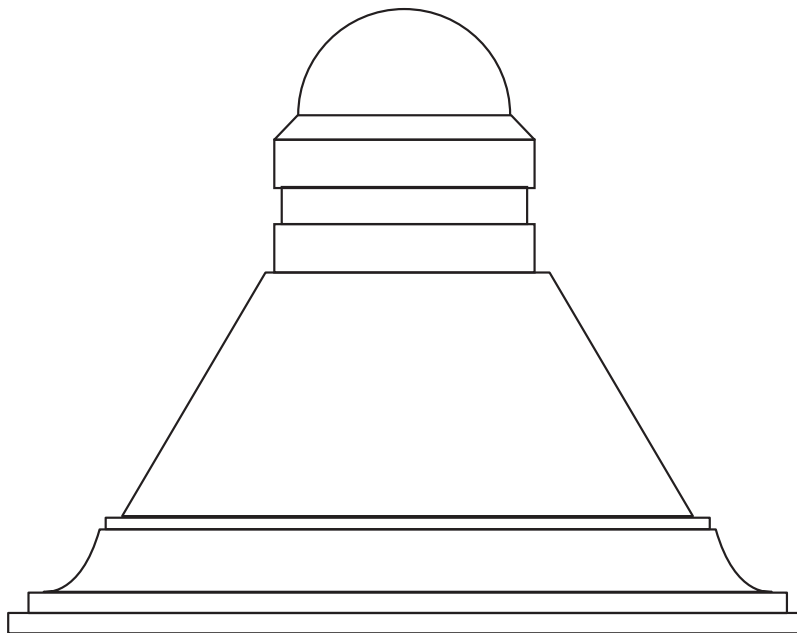

CAP 1 (C1)

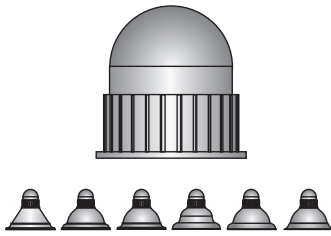

CAP 2 (C2)

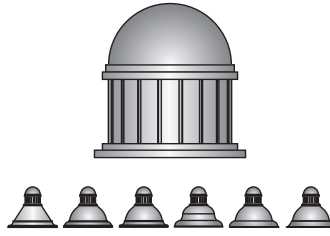

CAP 3 (C3)

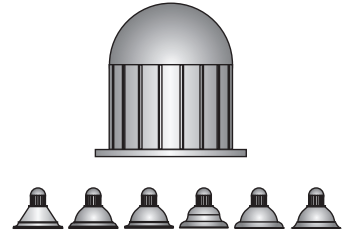

CAP 4 (C4)

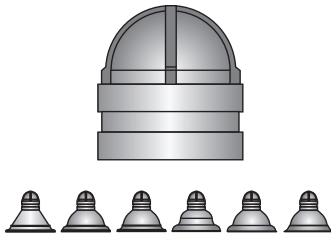

CAP 5 (C5)

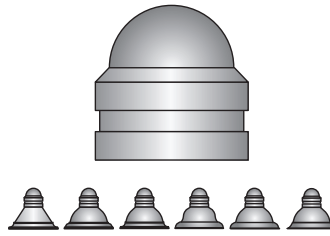

CAP 6 (C6)

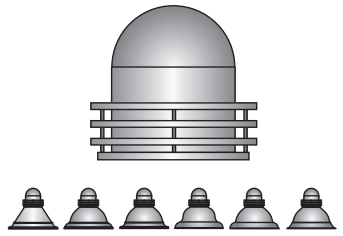

HOUSING 1 (H1)

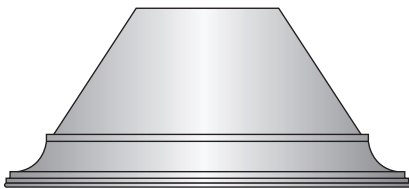

HOUSING 2 (H2)

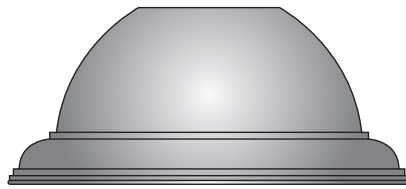

HOUSING 3 (H3)

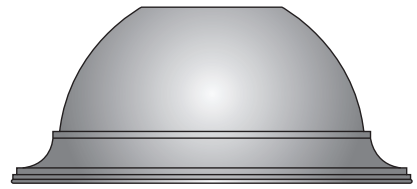

HOUSING 4 (H4)

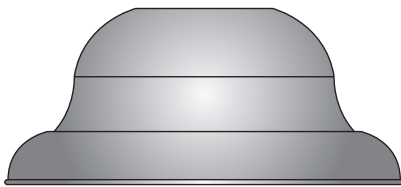

HOUSING 5 (H5)

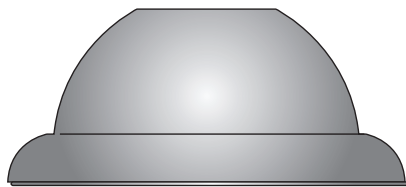

HOUSING 6 (H6)

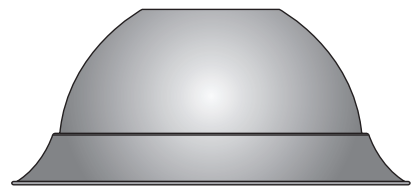

ODEN SIZE 1 - ELECTRICAL LOAD (A)							
Ordering Nomenclature	System Watts	120	208	240	277	347	480
ODN-1-L-16LD-3	16	0.13	0.08	0.07	0.06	0.05	0.03
ODN-1-L-16LD-5	25	0.21	0.12	0.10	0.09	0.07	0.05
ODN-1-L-16LD-7	34	0.28	0.16	0.14	0.12	0.10	0.07
ODN-1-L-32LD-3	33	0.28	0.16	0.14	0.12	0.10	0.07
ODN-1-L-32LD-5	51	0.43	0.25	0.21	0.18	0.15	0.11
ODN-1-L-32LD-7	68	0.57	0.33	0.28	0.25	0.20	0.14
ODN-1-L-48LD-3	49	0.41	0.24	0.20	0.18	0.14	0.10
ODN-1-L-48LD-5	76	0.63	0.37	0.32	0.27	0.22	0.16
ODN-1-L-48LD-7	105	0.88	0.50	0.44	0.38	0.30	0.22

ODEN SIZE 2 - ELECTRICAL LOAD (A)							
Ordering Nomenclature	System Watts	120	208	240	277	347	480
ODN-2-L-48LD-3	49	0.41	0.24	0.20	0.18	0.14	0.10
ODN-2-L-48LD-5	76	0.63	0.37	0.32	0.27	0.22	0.16
ODN-2-L-48LD-7	102	0.85	0.49	0.43	0.37	0.29	0.21
ODN-2-L-64LD-3	66	0.55	0.32	0.28	0.24	0.19	0.14
ODN-2-L-64LD-5	101	0.84	0.49	0.42	0.36	0.29	0.21
ODN-2-L-64LD-7	136	1.13	0.65	0.57	0.49	0.39	0.28
ODN-2-L-80LD-3	82	0.68	0.39	0.34	0.30	0.24	0.17
ODN-2-L-80LD-5	127	1.06	0.61	0.53	0.46	0.37	0.26
ODN-2-L-80LD-7	170	1.42	0.82	0.71	0.61	0.49	0.35
ODN-2-L-96LD-3	99	0.83	0.48	0.41	0.36	0.29	0.21
ODN-2-L-96LD-5	152	1.27	0.73	0.63	0.55	0.44	0.32
ODN-2-L-96LD-7	204	1.70	0.98	0.85	0.74	0.59	0.43

ODEN SIZE 3 - ELECTRICAL LOAD (A)							
Ordering Nomenclature	System Watts	120	208	240	277	347	480
ODN-3-L-96LD-3	99	0.83	0.48	0.41	0.36	0.29	0.21
ODN-3-L-96LD-5	152	1.27	0.73	0.63	0.55	0.44	0.32
ODN-3-L-96LD-7	204	1.70	0.98	0.85	0.74	0.59	0.43
ODN-3-L-128LD-3	136	1.13	0.65	0.57	0.49	0.39	0.28
ODN-3-L-128LD-5	203	1.69	0.98	0.85	0.73	0.59	0.42
ODN-3-L-128LD-7	272	2.27	1.31	1.13	0.98	0.78	0.57

Motion Sensor Default Settings								
High Mode	Low Mode	Time Delay	Cut Off	Sensitivity	Hold Off Set-point	Photocell	Ramp Up Time	Fade Down Time
10V	1V	5 Minutes	1 Hour	Maximum	4ft	Disabled	Disabled	Disabled

* Settings can be field modified with the FSIR-100 Programming remote

WATTSTOPPER PLUS

FSP-600 Series

The FSP-600 series by Wattstopper PLUS is an integrated luminaire level lighting controller and sensor for indoor/outdoor lighting applications that require networked wireless control. The FSP-600 is designed to integrate directly into exterior, high bay, parking garage, and general site lighting solutions. It is a passive infrared (PIR) sensor and closed loop photosensor.

The FSP-600 series design intends to reduce installer labor time and make on-site start up easy for technicians.

Once commissioned and paired to a Wattstopper PLUS network, the devices can measure both motion and daylight contribution in order to automatically switch or dim lighting. It also provides the ability to communicate to other fixtures in the space without any front-end devices.

The Wattstopper PLUS FSP-600 series is available in a few different options including: internal, external straight nipple, and external drop nipple. Sensor lens options sold separately and should be ordered based on designed mounting height and desired finish.

FSP-621



FSP-200 Series

The FSP-200 series sensors provide multi-level control based on motion and/or daylight contribution. They control 0-10 VDC LED drivers or dimming ballasts, as well as non-dimming ballasts and, with an FSP-Lx Lens, are rated for wet and cold locations. All control parameters are adjustable via a wireless configuration tool capable of storing and transmitting sensor profiles. The FSP-200 series is available in two different voltage configurations adding flexibility to your fixture design or project.

Typically, the sensor ramps lighting On to the selected High mode level when motion is detected and the ambient light level is below the hold off setpoint. After the sensor stops detecting movement and the time delay elapses, lights fade to the Low mode level. If there is no motion during the subsequent cut off time delay, the lights will turn Off. For dusk to dawn control, the integral photocell can switch the lights On and Off based on the ambient light level so that lighting remains on overnight even without motion detection.

Initial setup and subsequent sensor adjustments are made using a Wireless Handheld Configuration Tool (FSIR-100). This tool enables adjustment of parameters including high and low modes, sensitivity, time delay, cut off and more. The FSIR-100 is also used to initiate automatic calibration of the FSP-2x1B ambient light level setpoint. The setpoint is used to hold the controlled lighting off or at a low level when there is sufficient daylight. The wireless tool stores up to six sensor parameter profiles to speed configuration of multiple sensors.

FSP-211



FSP-221



Lens with Shroud Dimensions

The FSP-Lx-S models include a shroud, which blocks high-angle light coming from the fixture, to improve photocell performance. With the shroud attached, the dimensions for all three lenses are identical

FSP-L2-S and FSP-L3-S

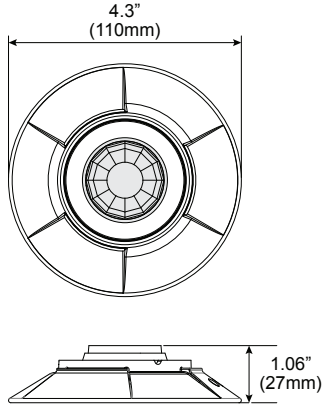

FSP-L7-S

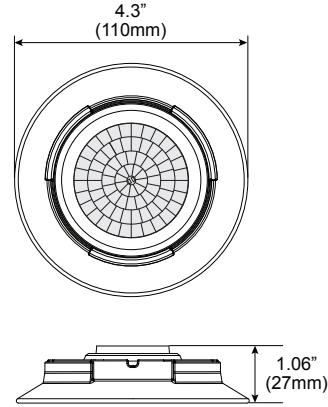

COVERAGE

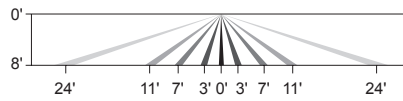
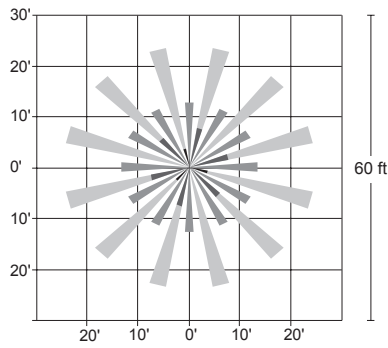

FSP-L2 top and side coverage patterns

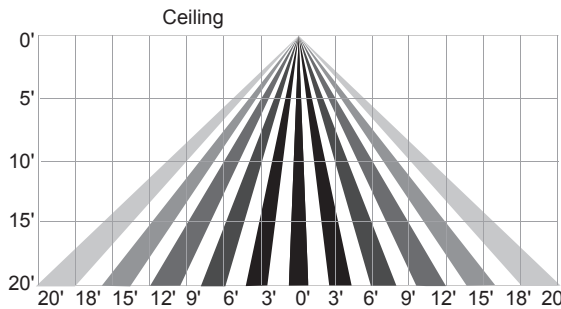
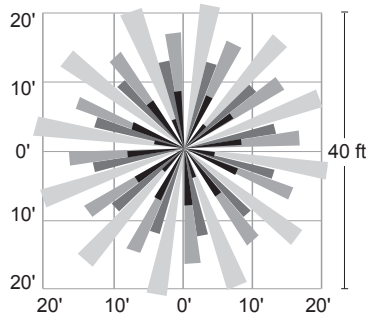

FSP-L3 top and side coverage patterns

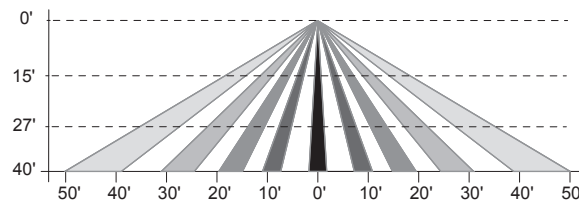
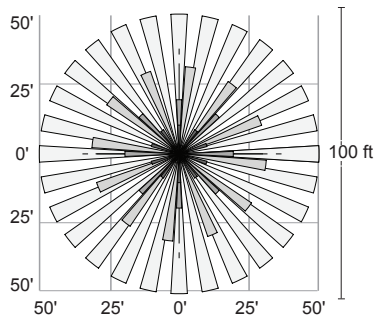

FSP-L7 top and side coverage patterns

ODN-1 LED SPECIFICATIONS / Forward Optics																											
Led Count	Current & Watts	Distribution Type	70CRI																								
			27K					30K					35K					40K					50K				
			Lumens	B	U	G	LPW	Lumens	B	U	G	LPW	Lumens	B	U	G	LPW	Lumens	B	U	G	LPW	Lumens	B	U	G	LPW
16LD	350 mA (16.4W)	T1	2419	2	0	2	147	2525	2	0	2	154	2525	2	0	2	154	2498	2	0	2	152	2630	2	0	2	160
		T2	2395	1	0	1	146	2499	1	0	1	152	2499	1	0	1	152	2473	1	0	1	151	2604	1	0	1	158
		T3R	2406	1	0	1	146	2511	1	0	1	153	2511	1	0	1	153	2485	1	0	1	151	2615	1	0	1	159
		T3	2352	1	0	1	143	2454	1	0	1	149	2454	1	0	1	149	2428	1	0	1	148	2556	1	0	1	156
		T3W	2435	1	0	1	148	2541	1	0	1	155	2541	1	0	1	155	2514	1	0	1	153	2647	1	0	1	161
		T3LG	2422	1	0	1	147	2527	1	0	1	154	2527	1	0	1	154	2501	1	0	1	152	2633	1	0	1	160
		T4	2383	1	0	1	145	2486	1	0	1	151	2486	1	0	1	151	2460	1	0	1	150	2590	1	0	1	158
		T4A	2524	1	0	1	154	2633	1	0	1	160	2633	1	0	1	160	2606	1	0	1	159	2743	1	0	1	167
		T4LG	2415	1	0	1	147	2520	1	0	1	153	2520	1	0	1	153	2494	1	0	1	152	2625	1	0	1	160
		T5	2516	1	0	1	153	2625	1	0	1	160	2625	1	0	1	160	2598	1	0	1	158	2735	2	0	1	166
		T5LG	2439	1	0	0	148	2545	1	0	0	155	2545	1	0	0	155	2518	1	0	0	153	2651	1	0	0	161
		T5W	2452	2	0	1	149	2559	2	0	1	156	2559	2	0	1	156	2532	2	0	1	154	2665	2	0	1	162
		T5WW	2328	2	0	1	142	2429	2	0	1	148	2429	2	0	1	148	2404	2	0	1	146	2530	2	0	1	154
		FN	2538	2	0	0	154	2648	2	0	0	161	2648	2	0	0	161	2620	2	0	0	159	2758	2	0	0	168
		FM	2541	2	0	0	155	2651	2	0	0	161	2651	2	0	0	161	2623	2	0	0	160	2762	2	0	0	168
		FW	2555	1	0	0	156	2666	1	0	0	162	2666	1	0	0	162	2639	1	0	0	161	2778	1	0	0	169
16LD	530 mA (25.3W)	T1	3581	2	0	2	141	3737	2	0	2	147	3737	2	0	2	147	3698	2	0	2	146	3892	2	0	2	154
		T2	3545	1	0	1	140	3699	1	0	1	146	3699	1	0	1	146	3661	1	0	1	144	3853	1	0	2	152
		T3R	3561	1	0	1	141	3716	1	0	2	147	3716	1	0	2	147	3677	1	0	1	145	3871	1	0	2	153
		T3	3480	1	0	1	137	3632	1	0	1	143	3632	1	0	1	143	3594	1	0	1	142	3783	1	0	1	149
		T3W	3604	1	0	1	142	3761	1	0	1	148	3761	1	0	1	148	3721	1	0	1	147	3917	1	0	1	155
		T3LG	3585	1	0	1	141	3741	1	0	1	148	3741	1	0	1	148	3702	1	0	1	146	3896	1	0	1	154
		T4	3527	1	0	1	139	3680	1	0	1	145	3680	1	0	1	145	3642	1	0	1	144	3833	1	0	1	151
		T4A	3735	1	0	1	147	3897	1	0	1	154	3897	1	0	1	154	3857	1	0	1	152	4060	1	0	1	160
		T4LG	3574	1	0	1	141	3730	1	0	1	147	3730	1	0	1	147	3691	1	0	1	146	3885	1	0	1	153
		T5	3724	2	0	1	147	3886	2	0	1	153	3886	2	0	1	153	3845	2	0	1	152	4047	2	0	1	160
		T5LG	3609	2	0	1	142	3766	2	0	1	149	3766	2	0	1	149	3727	2	0	1	147	3923	2	0	1	155
		T5W	3629	2	0	1	143	3787	2	0	1	149	3787	2	0	1	149	3747	2	0	1	148	3945	2	0	1	156
		T5WW	3445	2	0	1	136	3595	3	0	1	142	3595	3	0	1	142	3557	3	0	1	140	3745	3	0	1	148
		FN	3756	3	0	1	148	3919	3	0	1	155	3919	3	0	1	155	3878	3	0	1	153	4082	3	0	1	161
		FM	3760	3	0	1	148	3924	3	0	1	155	3924	3	0	1	155	3883	3	0	1	153	4087	3	0	1	161
		FW	3782	2	0	0	149	3946	2	0	0	156	3946	2	0	0	156	3905	2	0	0	154	4111	2	0	0	162
16LD	700 mA (34.0W)	T1	4641	3	0	3	137	4843	3	0	3	143	4843	3	0	3	143	4793	3	0	3	141	5045	3	0	3	149
		T2	4595	1	0	2	135	4795	1	0	2	141	4795	1	0	2	141	4745	1	0	2	140	4995	1	0	2	147
		T3R	4616	1	0	2	136	4817	1	0	2	142	4817	1	0	2	142	4766	1	0	2	140	5017	1	0	2	148
		T3	4511	1	0	1	133	4707	1	0	1	139	4707	1	0	1	139	4658	1	0	1	137	4903	1	0	1	144
		T3W	4671	1	0	2	138	4874	1	0	2	143	4874	1	0	2	143	4824	1	0	2	142	5078	1	0	2	149
		T3LG	4646	1	0	1	137	4848	1	0	1	143	4848	1	0	1	143	4798	1	0	1	141	5050	1	0	1	149
		T4	4571	1	0	1	135	4770	1	0	1	140	4770	1	0	1	140	4720	1	0	1	139	4968	1	0	1	146
		T4A	4841	1	0	1	143	5052	1	0	1	149	5052	1	0	1	149	4999	1	0	1	147	5262	1	0	1	155
		T4LG	4633	1	0	1	136	4834	1	0	1	142	4834	1	0	1	142	4784	1	0	1	141	5036	1	0	1	148
		T5	4827	2	0	1	142	5036	2	0	1	148	5036	2	0	1	148	4984	2	0	1	147	5246	2	0	1	154
		T5LG	4678	2	0	1	138	4882	2	0	1	144	4882	2	0	1	144	4831	2	0	1	142	5085	2	0	1	150
		T5W	4704	3	0	1	138	4908	3	0	1	144	4908	3	0	1	144	4857	3	0	1	143	5113	3	0	1	151
		T5WW	4465	3	0	1	131	4659	3	0	1	137	4659	3	0	1	137	4611	3	0	1	136	4854	3	0	1	143
		FN	4888	3	0	1	143	5080	3	0	1	150	5080	3	0	1	150	5027	3	0	1	148	5291	3	0	1	156
		FM	4874	3	0	1	143	5086	3	0	1	150	5086	3	0	1	150	5033	3	0	1	148	5298	3	0	1	156
		FW	4902	2	0	0	144	5115	2	0	0	151	5115	2	0	0	151	5062	2	0	0	149	5328	2	0	0	157

CRI Multiplier		
70 to 80 CRI	2700K, 3000K, 3500K, 4000K	5000K
	0.91	0.88
70 to 90 CRI	0.7	0.77

ODN-1 LED SPECIFICATIONS / Forward Optics																											
Led Count	Current & Watts	Distribution Type	70CRI																								
			27K					30K					35K					40K					50K				
			Lumens	B	U	G	LPW	Lumens	B	U	G	LPW	Lumens	B	U	G	LPW	Lumens	B	U	G	LPW	Lumens	B	U	G	LPW
32LD	350 mA (32.9W)	T1	4815	3	0	3	147	5024	3	0	3	153	5024	3	0	3	153	4972	3	0	3	151	5234	3	0	3	159
		T2	4767	1	0	2	145	4974	1	0	2	151	4974	1	0	2	151	4922	1	0	2	150	5181	1	0	2	158
		T3R	4788	1	0	2	146	4997	1	0	2	152	4997	1	0	2	152	4945	1	0	2	150	5205	1	0	2	158
		T3	4680	1	0	1	142	4883	1	0	1	149	4883	1	0	1	149	4832	1	0	1	147	5087	1	0	1	155
		T3W	4846	1	0	2	147	5057	1	0	2	154	5057	1	0	2	154	5004	1	0	2	152	5267	1	0	2	160
		T3LG	4820	1	0	1	147	5030	1	0	1	153	5030	1	0	1	153	4977	1	0	1	151	5239	1	0	1	159
		T4	4742	1	0	1	144	4948	1	0	1	151	4948	1	0	1	151	4896	1	0	1	149	5154	1	0	1	157
		T4A	5022	1	0	1	153	5241	1	0	1	159	5241	1	0	1	159	5186	1	0	1	158	5459	1	0	1	166
		T4LG	4806	1	0	1	146	5015	1	0	1	153	5015	1	0	1	153	4963	1	0	1	151	5224	1	0	1	159
		T5	5007	2	0	1	152	5225	2	0	1	159	5225	2	0	1	159	5170	2	0	1	157	5442	3	0	1	166
		T5LG	4853	2	0	1	148	5064	2	0	1	154	5064	2	0	1	154	5012	2	0	1	152	5275	2	0	1	161
		T5W	4880	3	0	1	148	5092	3	0	1	155	5092	3	0	1	155	5039	3	0	1	153	5304	3	0	1	161
		T5WW	4632	3	0	1	141	4834	3	0	1	147	4834	3	0	1	147	4783	3	0	1	146	5035	3	0	1	153
		FN	5050	3	0	1	154	5269	3	0	1	160	5269	3	0	1	160	5215	3	0	1	159	5489	3	0	1	167
		FM	5056	3	0	1	154	5276	3	0	1	161	5276	3	0	1	161	5221	3	0	1	159	5496	3	0	1	167
		FW	5085	2	0	0	155	5306	2	0	0	161	5306	2	0	0	161	5251	2	0	0	160	5528	2	0	1	168
32LD	530 mA (50.7W)	T1	7126	3	0	3	141	7436	3	0	3	147	7436	3	0	3	147	7359	3	0	3	145	7746	3	0	3	153
		T2	7055	2	0	2	139	7362	2	0	2	145	7362	2	0	2	145	7285	2	0	2	144	7669	2	0	2	151
		T3R	7087	2	0	2	140	7395	2	0	2	146	7395	2	0	2	146	7318	2	0	2	144	7703	2	0	2	152
		T3	6926	1	0	2	137	7227	1	0	2	143	7227	1	0	2	143	7152	1	0	2	141	7529	1	0	2	149
		T3W	7172	1	0	2	141	7484	1	0	2	148	7484	1	0	2	148	7406	1	0	2	146	7796	1	0	2	154
		T3LG	7134	2	0	2	141	7444	2	0	2	147	7444	2	0	2	147	7367	2	0	2	145	7754	2	0	2	153
		T4	7018	2	0	2	138	7323	2	0	2	144	7323	2	0	2	144	7247	2	0	2	143	7628	2	0	2	150
		T4A	7433	2	0	1	147	7756	2	0	1	153	7756	2	0	1	153	7676	2	0	1	151	8080	2	0	1	159
		T4LG	7113	2	0	2	140	7422	2	0	2	146	7422	2	0	2	146	7345	2	0	2	145	7731	2	0	2	153
		T5	7410	3	0	1	146	7733	3	0	1	153	7733	3	0	1	153	7652	3	0	1	151	8055	3	0	1	159
		T5LG	7183	3	0	1	142	7495	3	0	1	148	7495	3	0	1	148	7417	3	0	1	146	7808	3	0	1	154
		T5W	7222	3	0	1	142	7536	3	0	2	149	7536	3	0	2	149	7458	3	0	2	147	7850	3	0	2	155
		T5WW	6856	3	0	2	135	7154	3	0	2	141	7154	3	0	2	141	7079	3	0	2	140	7452	3	0	2	147
		FN	7474	4	0	1	147	7799	4	0	1	154	7799	4	0	1	154	7718	4	0	1	152	8124	4	0	1	160
		FM	7483	4	0	1	148	7809	4	0	1	154	7809	4	0	1	154	7727	4	0	1	152	8134	4	0	1	160
		FW	7527	3	0	1	148	7854	3	0	1	155	7854	3	0	1	155	7772	3	0	1	153	8181	3	0	1	161
32LD	700 mA (67.9W)	T1	9237	3	0	3	136	9639	3	0	3	142	9639	3	0	3	142	9538	3	0	3	140	10040	3	0	3	148
		T2	9145	2	0	3	135	9542	2	0	3	140	9542	2	0	3	140	9443	2	0	3	139	9940	2	0	3	146
		T3R	9186	2	0	3	135	9585	2	0	3	141	9585	2	0	3	141	9486	2	0	3	140	9985	2	0	3	147
		T3	8978	2	0	2	132	9368	2	0	2	138	9368	2	0	2	138	9270	2	0	2	136	9758	2	0	2	144
		T3W	9296	2	0	2	137	9701	2	0	2	143	9701	2	0	2	143	9600	2	0	2	141	10105	2	0	2	149
		T3LG	9247	2	0	2	136	9649	2	0	2	142	9649	2	0	2	142	9548	2	0	2	141	10051	2	0	2	148
		T4	9097	2	0	2	134	9492	2	0	2	140	9492	2	0	2	140	9393	2	0	2	138	9888	2	0	2	146
		T4A	9635	2	0	1	142	10054	2	0	1	148	10054	2	0	1	148	9949	2	0	1	146	10473	2	0	1	154
		T4LG	9220	2	0	2	136	9620	2	0	2	142	9620	2	0	2	142	9520	2	0	2	140	10021	2	0	2	147
		T5	9605	3	0	1	141	10023	3	0	2	148	10023	3	0	2	148	9918	3	0	2	146	10441	3	0	2	154
		T5LG	9311	3	0	1	137	9715	3	0	1	143	9715	3	0	1	143	9614	3	0	1	142	10120	3	0	1	149
		T5W	9361	3	0	2	138	9768	3	0	2	144	9768	3	0	2	144	9667	3	0	2	142	10175	4	0	2	150
		T5WW	8886	4	0	2	131	9273	4	0	2	136	9273	4	0	2	136	9176	4	0	2	135	9659	4	0	2	142
		FN	9688	4	0	1	143	10109	4	0	1	149	10109	4	0	1	149	10004	4	0	1	147	10530	4	0	1	155
		FM	9700	4	0	1	143	10121	4	0	1	149	10121	4	0	1	149	10016	4	0	1	147	10543	4	0	1	155
		FW	9756	3	0	1	144	10180	3	0	1	150	10180	3	0	1	150	10074	3	0	1	148	10604	3	0	1	156

CRI Multiplier		
70 to 80 CRI	2700K, 3000K, 3500K, 4000K	5000K
	0.91	0.88
70 to 90 CRI	0.7	0.77

ODN-1 LED SPECIFICATIONS / Forward Optics																											
Led Count	Current & Watts	Distribution Type	70CRI																								
			27K					30K					35K					40K					50K				
			Lumens	B	U	G	LPW	Lumens	B	U	G	LPW	Lumens	B	U	G	LPW	Lumens	B	U	G	LPW	Lumens	B	U	G	LPW
48LD	350 mA (49.3W)	T1	7186	3	0	3	146	7499	3	0	3	152	7499	3	0	3	152	7421	3	0	3	151	7811	3	0	3	158
		T2	7115	2	0	2	144	7424	2	0	2	151	7424	2	0	2	151	7347	2	0	2	149	7733	2	0	2	157
		T3R	7147	2	0	2	145	7458	2	0	2	151	7458	2	0	2	151	7380	2	0	2	150	7768	2	0	2	158
		T3	6985	1	0	2	142	7288	1	0	2	148	7288	1	0	2	148	7212	1	0	2	146	7592	1	0	2	154
		T3W	7233	1	0	2	147	7547	1	0	2	153	7547	1	0	2	153	7469	1	0	2	151	7862	1	0	2	159
		T3LG	7194	2	0	2	146	7507	2	0	2	152	7507	2	0	2	152	7429	2	0	2	151	7820	2	0	2	159
		T4	7077	2	0	2	144	7385	2	0	2	150	7385	2	0	2	150	7308	2	0	2	148	7693	2	0	2	156
		T4A	7496	2	0	1	152	7822	2	0	1	159	7822	2	0	1	159	7740	2	0	1	157	8148	2	0	1	165
		T4LG	7173	2	0	2	146	7485	2	0	2	152	7485	2	0	2	152	7407	2	0	2	150	7797	2	0	2	158
		T5	7473	3	0	1	152	7798	3	0	1	158	7798	3	0	1	158	7717	3	0	1	157	8123	3	0	1	165
		T5LG	7244	3	0	1	147	7559	3	0	1	153	7559	3	0	1	153	7480	3	0	1	152	7874	3	0	1	160
		T5W	7263	3	0	2	148	7600	3	0	2	154	7600	3	0	2	154	7521	3	0	2	153	7916	3	0	2	161
		T5WW	6914	3	0	2	140	7214	3	0	2	146	7214	3	0	2	146	7139	3	0	2	145	7515	3	0	2	152
		FN	7537	4	0	1	153	7865	4	0	1	160	7865	4	0	1	160	7783	4	0	1	158	8193	4	0	1	166
		FM	7546	4	0	1	153	7875	4	0	1	160	7875	4	0	1	160	7793	4	0	1	158	8203	4	0	1	166
		FW	7590	3	0	1	154	7920	3	0	1	161	7920	3	0	1	161	7838	3	0	1	159	8250	3	0	1	167
48LD	530 mA (76.0W)	T1	10636	4	0	4	140	11099	4	0	4	146	11099	4	0	4	146	10983	4	0	4	144	11561	4	0	4	152
		T2	10530	2	0	3	138	10988	3	0	3	145	10988	3	0	3	145	10873	2	0	3	143	11446	3	0	3	151
		T3R	10578	2	0	3	139	11038	3	0	3	145	11038	3	0	3	145	10923	3	0	3	144	11497	3	0	3	151
		T3	10338	2	0	2	136	10787	2	0	2	142	10787	2	0	2	142	10675	2	0	2	140	11237	2	0	2	148
		T3W	10705	2	0	3	141	11170	2	0	3	147	11170	2	0	3	147	11054	2	0	3	145	11636	2	0	3	153
		T3LG	10648	2	0	2	140	11111	2	0	2	146	11111	2	0	2	146	10995	2	0	2	145	11574	2	0	2	152
		T4	10475	2	0	2	138	10930	3	0	3	144	10930	3	0	3	144	10816	3	0	3	142	11386	3	0	3	150
		T4A	11094	2	0	1	146	11577	2	0	2	152	11577	2	0	2	152	11456	2	0	2	151	12059	2	0	2	159
		T4LG	10616	2	0	2	140	11078	2	0	2	146	11078	2	0	2	146	10962	2	0	2	144	11539	2	0	2	152
		T5	11060	3	0	2	145	11541	3	0	2	152	11541	3	0	2	152	11421	3	0	2	150	12022	3	0	2	158
		T5LG	10721	3	0	1	141	11187	3	0	2	147	11187	3	0	2	147	11071	3	0	2	146	11653	3	0	2	153
		T5W	10779	4	0	2	142	11248	4	0	2	148	11248	4	0	2	148	11131	4	0	2	146	11717	4	0	2	154
		T5WW	10233	4	0	2	135	10678	4	0	2	140	10678	4	0	2	140	10566	4	0	2	139	11122	4	0	2	146
		FN	11155	4	0	1	147	11640	4	0	1	153	11640	4	0	1	153	11519	4	0	1	152	12125	4	0	1	159
		FM	11169	4	0	1	147	11655	4	0	1	153	11655	4	0	1	153	11533	4	0	1	152	12140	4	0	1	160
		FW	11234	3	0	1	148	11722	3	0	1	154	11722	3	0	1	154	11600	3	0	1	153	12210	3	0	1	161
48LD	700 mA (101.9W)	T1	13786	4	0	4	135	14386	4	0	4	141	14386	4	0	4	141	14236	4	0	4	140	14985	4	0	4	147
		T2	13649	3	0	3	134	14242	3	0	3	140	14242	3	0	3	140	14094	3	0	3	138	14836	3	0	3	146
		T3R	13710	3	0	3	135	14307	3	0	3	140	14307	3	0	3	140	14158	3	0	3	139	14903	3	0	3	146
		T3	13400	2	0	2	131	13982	2	0	2	137	13982	2	0	2	137	13836	2	0	2	136	14565	2	0	2	143
		T3W	13875	2	0	3	136	14478	2	0	3	142	14478	2	0	3	142	14328	2	0	3	141	15082	2	0	3	148
		T3LG	13801	2	0	2	135	14401	3	0	2	141	14401	3	0	2	141	14251	3	0	2	140	15001	3	0	2	147
		T4	13577	3	0	3	133	14168	3	0	3	139	14168	3	0	3	139	14020	3	0	3	138	14758	3	0	3	145
		T4A	14380	3	0	2	141	15005	3	0	2	147	15005	3	0	2	147	14849	3	0	2	146	15631	3	0	2	153
		T4LG	13761	3	0	2	135	14359	3	0	2	141	14359	3	0	2	141	14209	3	0	2	139	14957	3	0	2	147
		T5	14336	4	0	2	141	14960	4	0	2	147	14960	4	0	2	147	14804	4	0	2	145	15583	4	0	2	153
		T5LG	13896	3	0	2	136	14501	3	0	2	142	14501	3	0	2	142	14349	3	0	2	141	15105	3	0	2	148
		T5W	13972	4	0	2	137	14579	4	0	2	143	14579	4	0	2	143	14428	4	0	2	142	15187	4	0	2	149
		T5WW	13263	4	0	2	130	13840	4	0	2	136	13840	4	0	2	136	13696	4	0	2	134	14417	4	0	2	141
		FN	14459	5	0	1	142	15088	5	0	1	148	15088	5	0	1	148	14931	5	0	1	147	15717	5	0	1	154
		FM	14477	4	0	1	142	15107	5	0	1	148	15107	5	0	1	148	14949	5	0	1	147	15736	5	0	1	154
		FW	14561	3	0	1	143	15194	4	0	1	149	15194	4	0	1	149	15036	4	0	1	148	15827	4	0	1	155
CRI Multiplier																											
70 to 80 CRI					2700K, 3000K, 3500K, 4000K					5000K																	
					0.91					0.88																	
70 to 90 CRI										0.77																	

ODN-2 LED SPECIFICATIONS / Forward Optics																											
Led Count	Current & Watts	Distribution Type	70CRI																								
			27K					30K					35K					40K					50K				
			Lumens	B	U	G	LPW	Lumens	B	U	G	LPW	Lumens	B	U	G	LPW	Lumens	B	U	G	LPW	Lumens	B	U	G	LPW
48LD	350 mA (49.3W)	T1	7256	3	0	3	147	7571	3	0	3	154	7571	3	0	3	154	7492	3	0	3	152	7887	3	0	3	160
		T2	7183	2	0	2	146	7496	2	0	2	152	7496	2	0	2	152	7417	2	0	2	150	7808	2	0	2	158
		T3R	7216	2	0	2	146	7530	2	0	2	153	7530	2	0	2	153	7451	2	0	2	151	7843	2	0	2	159
		T3	7052	1	0	2	143	7359	1	0	2	149	7359	1	0	2	149	7282	1	0	2	148	7665	1	0	2	155
		T3W	7302	1	0	2	148	7620	1	0	2	155	7620	1	0	2	155	7541	1	0	2	153	7937	1	0	2	161
		T3LG	7264	2	0	2	147	7579	2	0	2	154	7579	2	0	2	154	7500	2	0	2	152	7895	2	0	2	160
		T4	7146	2	0	2	145	7456	2	0	2	151	7456	2	0	2	151	7379	2	0	2	150	7767	2	0	2	158
		T4A	7588	2	0	1	154	7897	2	0	1	160	7897	2	0	1	160	7815	2	0	1	159	8226	2	0	1	167
		T4LG	7242	2	0	2	147	7557	2	0	2	153	7557	2	0	2	153	7478	2	0	2	152	7872	2	0	2	160
		T5	7545	3	0	1	153	7873	3	0	1	160	7873	3	0	1	160	7791	3	0	1	158	8201	3	0	1	166
		T5LG	7314	3	0	1	148	7632	3	0	1	155	7632	3	0	1	155	7552	3	0	1	153	7950	3	0	1	161
		T5W	7353	3	0	2	149	7673	3	0	2	156	7673	3	0	2	156	7593	3	0	2	154	7993	3	0	2	162
		T5WW	6980	3	0	2	142	7284	3	0	2	148	7284	3	0	2	148	7208	3	0	2	146	7587	3	0	2	154
		FN	7610	4	0	1	154	7941	4	0	1	161	7941	4	0	1	161	7858	4	0	1	159	8272	4	0	1	168
		FM	7619	4	0	1	155	7951	4	0	1	161	7951	4	0	1	161	7868	4	0	1	160	8282	4	0	1	168
		FW	7663	3	0	1	155	7996	3	0	1	162	7996	3	0	1	162	7913	3	0	1	161	8330	3	0	1	169
16LD	530 mA (25.3W)	T1	3581	2	0	2	141	3737	2	0	2	147	3737	2	0	2	147	3698	2	0	2	146	3892	2	0	2	154
		T2	3545	1	0	1	140	3699	1	0	1	146	3699	1	0	1	146	3661	1	0	1	144	3853	1	0	2	152
		T3R	3561	1	0	1	141	3716	1	0	2	147	3716	1	0	2	147	3677	1	0	1	145	3871	1	0	2	153
		T3	3480	1	0	1	137	3632	1	0	1	143	3632	1	0	1	143	3594	1	0	1	142	3783	1	0	1	149
		T3W	3604	1	0	1	142	3761	1	0	1	148	3761	1	0	1	148	3721	1	0	1	147	3917	1	0	1	155
		T3LG	3585	1	0	1	141	3741	1	0	1	148	3741	1	0	1	148	3702	1	0	1	146	3896	1	0	1	154
		T4	3527	1	0	1	139	3680	1	0	1	145	3680	1	0	1	145	3642	1	0	1	144	3833	1	0	1	151
		T4A	3735	1	0	1	147	3897	1	0	1	154	3897	1	0	1	154	3857	1	0	1	152	4060	1	0	1	160
		T4LG	3574	1	0	1	141	3730	1	0	1	147	3730	1	0	1	147	3691	1	0	1	146	3885	1	0	1	153
		T5	3724	2	0	1	147	3886	2	0	1	153	3886	2	0	1	153	3845	2	0	1	152	4047	2	0	1	160
		T5LG	3609	2	0	1	142	3766	2	0	1	149	3766	2	0	1	149	3727	2	0	1	147	3923	2	0	1	155
		T5W	3629	2	0	1	143	3787	2	0	1	149	3787	2	0	1	149	3747	2	0	1	148	3945	2	0	1	156
		T5WW	3445	2	0	1	136	3595	3	0	1	142	3595	3	0	1	142	3557	3	0	1	140	3745	3	0	1	148
		FN	3756	3	0	1	148	3919	3	0	1	155	3919	3	0	1	155	3878	3	0	1	153	4082	3	0	1	161
		FM	3760	3	0	1	148	3924	3	0	1	155	3924	3	0	1	155	3883	3	0	1	153	4087	3	0	1	161
		FW	3782	2	0	0	149	3946	2	0	0	156	3946	2	0	0	156	3905	2	0	0	154	4111	2	0	0	162
16LD	700 mA (34.0W)	T1	4641	3	0	3	137	4843	3	0	3	143	4843	3	0	3	143	4793	3	0	3	141	5045	3	0	3	149
		T2	4595	1	0	2	135	4795	1	0	2	141	4795	1	0	2	141	4745	1	0	2	140	4995	1	0	2	147
		T3R	4616	1	0	2	136	4817	1	0	2	142	4817	1	0	2	142	4766	1	0	2	140	5017	1	0	2	148
		T3	4511	1	0	1	133	4707	1	0	1	139	4707	1	0	1	139	4658	1	0	1	137	4903	1	0	1	144
		T3W	4671	1	0	2	138	4874	1	0	2	143	4874	1	0	2	143	4824	1	0	2	142	5078	1	0	2	149
		T3LG	4646	1	0	1	137	4848	1	0	1	143	4848	1	0	1	143	4798	1	0	1	141	5050	1	0	1	149
		T4	4571	1	0	1	135	4770	1	0	1	140	4770	1	0	1	140	4720	1	0	1	139	4968	1	0	1	146
		T4A	4841	1	0	1	143	5052	1	0	1	149	5052	1	0	1	149	4999	1	0	1	147	5262	1	0	1	155
		T4LG	4633	1	0	1	136	4834	1	0	1	142	4834	1	0	1	142	4784	1	0	1	141	5036	1	0	1	148
		T5	4827	2	0	1	142	5036	2	0	1	148	5036	2	0	1	148	4984	2	0	1	147	5246	2	0	1	154
		T5LG	4678	2	0	1	138	4882	2	0	1	144	4882	2	0	1	144	4831	2	0	1	142	5085	2	0	1	150
		T5W	4704	3	0	1	138	4908	3	0	1	144	4908	3	0	1	144	4857	3	0	1	143	5113	3	0	1	151
		T5WW	4465	3	0	1	131	4659	3	0	1	137	4659	3	0	1	137	4611	3	0	1	136	4854	3	0	1	143
		FN	4888	3	0	1	143	5080	3	0	1	150	5080	3	0	1	150	5027	3	0	1	148	5291	3	0	1	156
		FM	4874	3	0	1	143	5086	3	0	1	150	5086	3	0	1	150	5033	3	0	1	148	5298	3	0	1	156
		FW	4902	2	0	0	144	5115	2	0	0	151	5115	2	0	0	151	5062	2	0	0	149	5328	2	0	0	157

CRI Multiplier		
70 to 80 CRI	2700K, 3000K, 3500K, 4000K	5000K
	0.91	0.88
70 to 90 CRI	0.7	0.77

ODN-2 LED SPECIFICATIONS / Forward Optics																											
Led Count	Current & Watts	Distribution Type	70CRI																								
			27K					30K					35K					40K					50K				
			Lumens	B	U	G	LPW	Lumens	B	U	G	LPW	Lumens	B	U	G	LPW	Lumens	B	U	G	LPW	Lumens	B	U	G	LPW
64LD	350 mA (65.7W)	T1	9627	3	0	3	146	10045	3	0	3	153	10045	3	0	3	153	9941	3	0	3	151	10464	4	0	4	159
		T2	9530	2	0	3	145	9945	2	0	3	151	9945	2	0	3	151	9841	2	0	3	150	10359	2	0	3	158
		T3R	9574	2	0	3	146	9990	2	0	3	152	9990	2	0	3	152	9886	2	0	3	150	10406	2	0	3	158
		T3	9356	2	0	2	142	9763	2	0	2	149	9763	2	0	2	149	9662	2	0	2	147	10170	2	0	2	155
		T3W	9689	2	0	2	147	10110	2	0	2	154	10110	2	0	2	154	10005	2	0	2	152	10531	2	0	3	160
		T3LG	9637	2	0	2	147	10056	2	0	2	153	10056	2	0	2	153	9951	2	0	2	151	10475	2	0	2	159
		T4	9481	2	0	2	144	9893	2	0	2	151	9893	2	0	2	151	9790	2	0	2	149	10305	2	0	2	157
		T4A	10041	2	0	1	153	10478	2	0	1	159	10478	2	0	1	159	10369	2	0	1	158	10914	2	0	1	166
		T4LG	9609	2	0	2	146	10026	2	0	2	153	10026	2	0	2	153	9922	2	0	2	151	10444	2	0	2	159
		T5	10011	3	0	2	152	10446	3	0	2	159	10446	3	0	2	159	10337	3	0	2	157	10881	3	0	2	166
		T5LG	9703	3	0	1	148	10125	3	0	1	154	10125	3	0	1	154	10020	3	0	1	152	10547	3	0	1	160
		T5W	9756	3	0	2	148	10180	4	0	2	155	10180	4	0	2	155	10074	3	0	2	153	10605	4	0	2	161
		T5WW	9261	4	0	2	141	9664	4	0	2	147	9664	4	0	2	147	9563	4	0	2	145	10067	4	0	2	153
		FN	10097	4	0	1	154	10535	4	0	1	160	10535	4	0	1	160	10426	4	0	1	159	10974	4	0	1	167
		FM	10109	4	0	1	154	10549	4	0	1	160	10549	4	0	1	160	10439	4	0	1	159	10988	4	0	1	167
		FW	10167	3	0	1	155	10609	3	0	1	161	10609	3	0	1	161	10499	3	0	1	160	11051	3	0	1	168
64LD	530 mA (101.4W)	T1	14248	4	0	4	141	14867	4	0	4	147	14867	4	0	4	147	14713	4	0	4	145	15487	4	0	4	153
		T2	14106	3	0	3	139	14719	3	0	3	145	14719	3	0	3	145	14566	3	0	3	144	15332	3	0	3	151
		T3R	14169	3	0	3	140	14786	3	0	3	146	14786	3	0	3	146	14632	3	0	3	144	15402	3	0	3	152
		T3	13848	2	0	2	137	14450	2	0	2	143	14450	2	0	2	143	14300	2	0	2	141	15052	2	0	2	148
		T3W	14340	2	0	3	141	14963	2	0	3	148	14963	2	0	3	148	14807	2	0	3	146	15587	2	0	3	154
		T3LG	14263	3	0	2	141	14883	3	0	2	147	14883	3	0	2	147	14728	3	0	2	145	15504	3	0	3	153
		T4	14032	3	0	3	138	14642	3	0	3	144	14642	3	0	3	144	14489	3	0	3	143	15252	3	0	3	150
		T4A	14862	3	0	2	147	15508	3	0	2	153	15508	3	0	2	153	15346	3	0	2	151	16154	3	0	2	159
		T4LG	14221	3	0	2	140	14840	3	0	2	146	14840	3	0	2	146	14685	3	0	2	145	15458	3	0	2	152
		T5	14816	4	0	2	146	15460	4	0	2	153	15460	4	0	2	153	15299	4	0	2	151	16105	4	0	2	159
		T5LG	14362	3	0	2	142	14986	3	0	2	148	14986	3	0	2	148	14830	3	0	2	146	15610	4	0	2	154
		T5W	14440	4	0	2	142	15068	4	0	2	149	15068	4	0	2	149	14911	4	0	2	147	15695	4	0	2	155
		T5WW	13707	4	0	2	135	14303	4	0	2	141	14303	4	0	2	141	14154	4	0	2	140	14899	4	0	2	147
		FN	14943	5	0	1	147	15593	5	0	1	154	15593	5	0	1	154	15431	5	0	1	152	16243	5	0	1	160
		FM	14962	5	0	1	148	15612	5	0	1	154	15612	5	0	1	154	15450	5	0	1	152	16263	5	0	1	160
		FW	15048	4	0	1	148	15702	4	0	1	155	15702	4	0	1	155	15539	4	0	1	153	16357	4	0	1	161
64LD	700 mA (135.9W)	T1	18468	4	0	4	136	19271	4	0	4	142	19271	4	0	4	142	19070	4	0	4	140	20074	4	0	4	148
		T2	18283	3	0	3	135	19078	3	0	3	140	19078	3	0	3	140	18880	3	0	3	139	19873	3	0	3	146
		T3R	18366	3	0	3	135	19165	3	0	3	141	19165	3	0	3	141	18965	3	0	3	140	19963	3	0	3	147
		T3	17950	3	0	3	132	18730	3	0	3	138	18730	3	0	3	138	18535	3	0	3	136	19510	3	0	3	144
		T3W	18587	3	0	3	137	19395	3	0	3	143	19395	3	0	3	143	19193	3	0	3	141	20203	3	0	3	149
		T3LG	18488	3	0	3	136	19292	3	0	3	142	19292	3	0	3	142	19091	3	0	3	140	20095	3	0	3	148
		T4	18188	3	0	3	134	18978	3	0	3	140	18978	3	0	3	140	18781	3	0	3	138	19769	3	0	3	145
		T4A	19263	3	0	2	142	20101	3	0	2	148	20101	3	0	2	148	19891	3	0	2	146	20938	3	0	2	154
		T4LG	18433	3	0	3	136	19235	3	0	3	142	19235	3	0	3	142	19034	3	0	3	140	20036	3	0	3	147
		T5	19204	4	0	2	141	20039	4	0	2	147	20039	4	0	2	147	19831	4	0	2	146	20874	4	0	2	154
		T5LG	18615	4	0	2	137	19424	4	0	2	143	19424	4	0	2	143	19222	4	0	2	141	20234	4	0	2	149
		T5W	18716	4	0	2	138	19530	4	0	2	144	19530	4	0	2	144	19327	4	0	2	142	20344	5	0	3	150
		T5WW	17767	5	0	3	131	18540	5	0	3	136	18540	5	0	3	136	18347	5	0	3	135	19312	5	0	3	142
		FN	19369	5	0	1	143	20211	5	0	1	149	20211	5	0	1	149	20001	5	0	1	147	21053	5	0	1	155
		FM	19393	5	0	1	143	20236	5	0	1	149	20236	5	0	1	149	20026	5	0	1	147	21080	5	0	1	155
		FW	19505	4	0	1	144	20353	4	0	1	150	20353	4	0	1	150	20141	4	0	1	148	21201	4	0	1	156
CRI Multiplier																											
					2700K, 3000K, 3500K, 4000K										5000K												
70 to 80 CRI					0.91										0.88												
70 to 90 CRI					0.7										0.77												

ODN-2 LED SPECIFICATIONS / Forward Optics																											
Led Count	Current & Watts	Distribution Type	70CRI																								
			27K					30K					35K					40K					50K				
			Lumens	B	U	G	LPW	Lumens	B	U	G	LPW	Lumens	B	U	G	LPW	Lumens	B	U	G	LPW	Lumens	B	U	G	LPW
80LD	350 mA (62.2W)	T1	11974	4	0	4	146	12494	4	0	4	152	12494	4	0	4	152	12364	4	0	4	150	13015	4	0	4	158
		T2	11854	3	0	3	144	12370	3	0	3	151	12370	3	0	3	151	12241	3	0	3	149	12885	3	0	3	157
		T3R	11908	3	0	3	145	12426	3	0	3	151	12426	3	0	3	151	12296	3	0	3	150	12943	3	0	3	158
		T3	11638	2	0	2	142	12144	2	0	2	148	12144	2	0	2	148	12017	2	0	2	146	12650	2	0	2	154
		T3W	12051	2	0	3	147	12575	2	0	3	153	12575	2	0	3	153	12444	2	0	3	151	13099	2	0	3	159
		T3LG	11987	2	0	2	146	12508	2	0	2	152	12508	2	0	2	152	12378	2	0	2	151	13029	2	0	2	159
		T4	11792	3	0	3	144	12305	3	0	3	150	12305	3	0	3	150	12177	3	0	3	148	12817	3	0	3	156
		T4A	12490	2	0	2	152	13033	2	0	2	159	13033	2	0	2	159	12897	2	0	2	157	13576	2	0	2	165
		T4LG	11951	2	0	2	145	12471	2	0	2	152	12471	2	0	2	152	12341	2	0	2	150	12991	2	0	2	158
		T5	12451	3	0	2	152	12993	3	0	2	158	12993	3	0	2	158	12857	3	0	2	156	13534	4	0	2	165
		T5LG	12069	3	0	2	147	12594	3	0	2	153	12594	3	0	2	153	12463	3	0	2	152	13119	3	0	2	160
		T5W	12135	4	0	2	148	12663	4	0	2	154	12663	4	0	2	154	12531	4	0	2	153	13190	4	0	2	161
		T5WW	11519	4	0	2	140	12020	4	0	2	146	12020	4	0	2	146	11895	4	0	2	145	12521	4	0	2	152
		FN	12558	4	0	1	153	13104	4	0	1	159	13104	4	0	1	159	12968	4	0	1	158	13650	4	0	1	166
		FM	12574	4	0	1	153	13120	4	0	1	160	13120	4	0	1	160	12984	4	0	1	158	13667	4	0	1	166
		FW	12646	3	0	1	154	13196	3	0	1	161	13196	3	0	1	161	13059	3	0	1	159	13746	3	0	1	167
80LD	530 mA (126.7W)	T1	17722	4	0	4	140	18492	4	0	4	146	18492	4	0	4	146	18300	4	0	4	144	19263	4	0	4	152
		T2	17545	3	0	3	138	18307	3	0	3	144	18307	3	0	3	144	18117	3	0	3	143	19070	3	0	4	150
		T3R	17624	3	0	3	139	18390	3	0	3	145	18390	3	0	3	145	18199	3	0	3	144	19157	3	0	4	151
		T3	17224	3	0	3	136	17973	3	0	3	142	17973	3	0	3	142	17786	3	0	3	140	18722	3	0	3	148
		T3W	17836	3	0	3	141	18611	3	0	3	147	18611	3	0	3	147	18417	3	0	3	145	19387	3	0	3	153
		T3LG	17741	3	0	3	140	18512	3	0	3	146	18512	3	0	3	146	18319	3	0	3	145	19284	3	0	3	152
		T4	17453	3	0	3	138	18212	3	0	3	144	18212	3	0	3	144	18022	3	0	3	142	18971	3	0	3	150
		T4A	18485	3	0	2	146	19289	3	0	2	152	19289	3	0	2	152	19088	3	0	2	151	20092	3	0	2	159
		T4LG	17688	3	0	3	140	18458	3	0	3	146	18458	3	0	3	146	18265	3	0	3	144	19227	3	0	3	152
		T5	18429	4	0	2	145	19230	4	0	2	152	19230	4	0	2	152	19029	4	0	2	150	20031	4	0	2	158
		T5LG	17863	4	0	2	141	18640	4	0	2	147	18640	4	0	2	147	18446	4	0	2	146	19416	4	0	2	153
		T5W	17960	4	0	2	142	18741	4	0	2	148	18741	4	0	2	148	18546	4	0	2	146	19522	4	0	2	154
		T5WW	17049	4	0	2	135	17791	5	0	3	140	17791	5	0	3	140	17605	4	0	2	139	18532	5	0	3	146
		FN	18587	5	0	1	147	19395	5	0	1	153	19395	5	0	1	153	19193	5	0	1	151	20203	5	0	1	159
		FM	18610	5	0	1	147	19419	5	0	1	153	19419	5	0	1	153	19216	5	0	1	152	20228	5	0	1	160
		FW	18717	4	0	1	148	19531	4	0	1	154	19531	4	0	1	154	19327	4	0	1	153	20345	4	0	1	161
80LD	700 mA (169.9W)	T1	22971	5	0	5	135	23969	5	0	5	141	23969	5	0	5	141	23720	5	0	5	140	24968	5	0	5	147
		T2	22741	3	0	4	134	23730	3	0	4	140	23730	3	0	4	140	23483	3	0	4	138	24719	3	0	4	146
		T3R	22844	3	0	4	134	23837	3	0	4	140	23837	3	0	4	140	23589	3	0	4	139	24830	3	0	4	146
		T3	22326	3	0	3	131	23297	3	0	3	137	23297	3	0	3	137	23054	3	0	3	136	24267	3	0	3	143
		T3W	23118	3	0	3	136	24124	3	0	4	142	24124	3	0	4	142	23872	3	0	4	141	25129	3	0	4	148
		T3LG	22995	3	0	3	135	23995	3	0	3	141	23995	3	0	3	141	23745	3	0	3	140	24995	3	0	3	147
		T4	22622	3	0	4	133	23606	3	0	4	139	23606	3	0	4	139	23360	3	0	4	138	24589	3	0	4	145
		T4A	23960	3	0	3	141	25002	3	0	3	147	25002	3	0	3	147	24741	3	0	3	146	26043	3	0	3	153
		T4LG	22927	3	0	3	135	23924	3	0	3	141	23924	3	0	3	141	23675	3	0	3	139	24921	3	0	3	147
		T5	23887	4	0	2	141	24925	4	0	2	147	24925	4	0	2	147	24666	4	0	2	145	25964	4	0	2	153
		T5LG	23154	4	0	2	136	24160	4	0	2	142	24160	4	0	2	142	23909	4	0	2	141	25167	4	0	2	148
		T5W	23280	5	0	3	137	24292	5	0	3	143	24292	5	0	3	143	24039	5	0	3	142	25304	5	0	3	149
		T5WW	22099	5	0	3	130	23060	5	0	3	136	23060	5	0	3	136	22820	5	0	3	134	24021	5	0	3	141
		FN	24092	5	0	1	142	25139	5	0	1	148	25139	5	0	1	148	24877	5	0	1	146	26187	5	0	1	154
		FM	24121	5	0	1	142	25170	5	0	1	148	25170	5	0	1	148	24908	5	0	1	147	26219	5	0	1	154
		FW	24261	4	0	1	143	25316	5	0	1	149	25316	5	0	1	149	25052	5	0	1	147	26370	5	0	1	155

CRI Multiplier		
	2700K, 3000K, 3500K, 4000K	5000K
70 to 60 CRI	0.91	0.88
70 to 90 CRI	0.7	0.77

ODN-2 LED SPECIFICATIONS / Forward Optics																											
Led Count	Current & Watts	Distribution Type	70CRI																								
			27K					30K					35K					40K					50K				
			Lumens	B	U	G	LPW	Lumens	B	U	G	LPW	Lumens	B	U	G	LPW	Lumens	B	U	G	LPW	Lumens	B	U	G	LPW
96LD	350 mA (98.6W)	T1	14275	4	0	4	145	14896	4	0	4	151	14896	4	0	4	151	14741	4	0	4	150	15517	4	0	4	157
		T2	14133	3	0	3	143	14747	3	0	3	150	14747	3	0	3	150	14594	3	0	3	148	15362	3	0	3	156
		T3R	14197	3	0	3	144	14814	3	0	3	150	14814	3	0	3	150	14660	3	0	3	149	15431	3	0	3	157
		T3	13875	2	0	2	141	14478	2	0	2	147	14478	2	0	2	147	14327	2	0	2	145	15081	2	0	2	153
		T3W	14367	2	0	3	146	14992	2	0	3	152	14992	2	0	3	152	14836	2	0	3	150	15617	2	0	3	158
		T3LG	14291	3	0	2	145	14912	3	0	2	151	14912	3	0	2	151	14757	3	0	2	150	15534	3	0	3	158
		T4	14059	3	0	3	143	14670	3	0	3	149	14670	3	0	3	149	14517	3	0	3	147	15281	3	0	3	155
		T4A	14890	3	0	2	151	15538	3	0	2	158	15538	3	0	2	158	15376	3	0	2	156	16185	3	0	2	164
		T4LG	14249	3	0	2	145	14868	3	0	2	151	14868	3	0	2	151	14713	3	0	2	149	15488	3	0	2	157
		T5	14845	4	0	2	151	15490	4	0	2	157	15490	4	0	2	157	15329	4	0	2	155	16136	4	0	2	164
		T5LG	14389	3	0	2	146	15015	3	0	2	152	15015	3	0	2	152	14858	3	0	2	151	15640	4	0	2	159
		T5W	14468	4	0	2	147	15097	4	0	2	153	15097	4	0	2	153	14939	4	0	2	152	15726	4	0	2	159
		T5WW	13734	4	0	2	139	14331	4	0	2	145	14331	4	0	2	145	14182	4	0	2	144	14928	4	0	2	151
		FN	14972	5	0	1	152	15623	5	0	1	158	15623	5	0	1	158	15460	5	0	1	157	16274	5	0	1	165
		FM	14991	5	0	1	152	15642	5	0	1	159	15642	5	0	1	159	15480	5	0	1	157	16294	5	0	1	165
		FW	15077	4	0	1	153	15733	4	0	1	160	15733	4	0	1	160	15569	4	0	1	158	16388	4	0	1	166
96LD	530 mA (152.1W)	T1	21128	5	0	5	139	22047	5	0	5	145	22047	5	0	5	145	21817	5	0	5	143	22966	5	0	5	151
		T2	20917	3	0	4	138	21827	3	0	4	144	21827	3	0	4	144	21599	3	0	4	142	22736	3	0	4	150
		T3R	21012	3	0	4	138	21926	3	0	4	144	21926	3	0	4	144	21697	3	0	4	143	22839	3	0	4	150
		T3	20535	3	0	3	135	21428	3	0	3	141	21428	3	0	3	141	21205	3	0	3	139	22321	3	0	3	147
		T3W	21264	3	0	3	140	22189	3	0	3	146	22189	3	0	3	146	21958	3	0	3	144	23114	3	0	3	152
		T3LG	21151	3	0	3	139	22071	3	0	3	145	22071	3	0	3	145	21841	3	0	3	144	22990	3	0	3	151
		T4	20808	3	0	3	137	21712	3	0	3	143	21712	3	0	3	143	21486	3	0	3	141	22617	3	0	4	149
		T4A	22038	3	0	2	145	22997	3	0	3	151	22997	3	0	3	151	22757	3	0	3	150	23955	3	0	3	158
		T4LG	21089	3	0	3	139	22006	3	0	3	145	22006	3	0	3	145	21776	3	0	3	143	22923	3	0	3	151
		T5	21971	4	0	2	144	22926	4	0	2	151	22926	4	0	2	151	22687	4	0	2	149	23882	4	0	2	157
		T5LG	21297	4	0	2	140	22223	4	0	2	146	22223	4	0	2	146	21991	4	0	2	145	23149	4	0	2	152
		T5W	21413	5	0	3	141	22344	5	0	3	147	22344	5	0	3	147	22111	5	0	3	145	23275	5	0	3	153
		T5WW	20327	5	0	3	134	21211	5	0	3	139	21211	5	0	3	139	20990	5	0	3	138	22094	5	0	3	145
		FN	22160	5	0	1	146	23123	5	0	1	152	23123	5	0	1	152	22882	5	0	1	150	24086	5	0	1	158
		FM	22187	5	0	1	146	23152	5	0	1	152	23152	5	0	1	152	22910	5	0	1	151	24116	5	0	1	159
		FW	22315	4	0	1	147	23285	4	0	1	153	23285	4	0	1	153	23043	4	0	1	152	24256	4	0	1	160
96LD	700 mA (203.8W)	T1	27386	5	0	5	134	28577	5	0	5	140	28577	5	0	5	140	28279	5	0	5	139	29768	5	0	5	146
		T2	27112	3	0	4	133	28291	4	0	5	139	28291	4	0	5	139	27997	4	0	5	137	29470	4	0	5	145
		T3R	27235	4	0	4	134	28419	4	0	5	139	28419	4	0	5	139	28123	4	0	5	138	29604	4	0	5	145
		T3	26618	3	0	3	131	27775	3	0	4	136	27775	3	0	4	136	27485	3	0	4	135	28932	3	0	4	142
		T3W	27562	3	0	4	135	28761	3	0	4	141	28761	3	0	4	141	28461	3	0	4	140	29959	3	0	4	147
		T3LG	27416	3	0	4	135	28608	3	0	4	140	28608	3	0	4	140	28310	3	0	4	139	29800	3	0	4	146
		T4	26971	4	0	4	132	28143	4	0	4	138	28143	4	0	4	138	27850	4	0	4	137	29316	4	0	4	144
		T4A	28566	3	0	3	140	29808	3	0	3	146	29808	3	0	3	146	29497	3	0	3	145	31050	3	0	3	152
		T4LG	27335	3	0	4	134	28523	3	0	4	140	28523	3	0	4	140	28226	3	0	4	138	29712	3	0	4	146
		T5	28478	5	0	3	140	29716	5	0	3	146	29716	5	0	3	146	29407	5	0	3	144	30955	5	0	3	152
		T5LG	27604	4	0	2	135	28805	4	0	2	141	28805	4	0	2	141	28505	4	0	2	140	30005	5	0	2	147
		T5W	27755	5	0	3	136	28962	5	0	3	142	28962	5	0	3	142	28660	5	0	3	141	30168	5	0	3	148
		T5WW	26347	5	0	3	129	27493	5	0	4	135	27493	5	0	4	135	27206	5	0	4	133	28638	5	0	4	141
		FN	28723	5	0	1	141	29972	5	0	1	147	29972	5	0	1	147	29659	5	0	1	146	31220	5	0	1	153
		FM	28758	5	0	1	141	30009	5	0	1	147	30009	5	0	1	147	29696	5	0	1	146	31259	5	0	1	153
		FW	28924	5	0	1	142	30182	5	0	1	148	30182	5	0	1	148	29867	5	0	1	147	31439	5	0	1	154

CRI Multiplier		
70 to 80 CRI	2700K, 3000K, 3500K, 4000K	5000K
	0.91	0.88
70 to 90 CRI	0.7	0.77

ODN-3 LED SPECIFICATIONS / Forward Optics																											
Led Count	Current & Watts	Distribution Type	70CRI																								
			27K					30K					35K					40K					50K				
			Lumens	B	U	G	LPW	Lumens	B	U	G	LPW	Lumens	B	U	G	LPW	Lumens	B	U	G	LPW	Lumens	B	U	G	LPW
96LD	350 mA (98.6W)	T1	14275	4	0	4	145	14896	4	0	4	151	14896	4	0	4	151	14741	4	0	4	150	15517	4	0	4	157
		T2	14133	3	0	3	143	14747	3	0	3	150	14747	3	0	3	150	14594	3	0	3	148	15362	3	0	3	156
		T3R	14197	3	0	3	144	14814	3	0	3	150	14814	3	0	3	150	14660	3	0	3	149	15431	3	0	3	157
		T3	13875	2	0	2	141	14478	2	0	2	147	14478	2	0	2	147	14327	2	0	2	145	15081	2	0	2	153
		T3W	14367	2	0	3	146	14992	2	0	3	152	14992	2	0	3	152	14836	2	0	3	150	15617	2	0	3	158
		T3LG	14291	3	0	2	145	14912	3	0	2	151	14912	3	0	2	151	14757	3	0	2	150	15534	3	0	3	158
		T4	14059	3	0	3	143	14670	3	0	3	149	14670	3	0	3	149	14517	3	0	3	147	15281	3	0	3	155
		T4A	14890	3	0	2	151	15538	3	0	2	158	15538	3	0	2	158	15376	3	0	2	156	16185	3	0	2	164
		T4LG	14249	3	0	2	145	14868	3	0	2	151	14868	3	0	2	151	14713	3	0	2	149	15488	3	0	2	157
		T5	14845	4	0	2	151	15490	4	0	2	157	15490	4	0	2	157	15329	4	0	2	155	16136	4	0	2	164
		T5LG	14389	3	0	2	146	15015	3	0	2	152	15015	3	0	2	152	14858	3	0	2	151	15640	4	0	2	159
		T5W	14468	4	0	2	147	15097	4	0	2	153	15097	4	0	2	153	14939	4	0	2	152	15726	4	0	2	159
		T5WW	13734	4	0	2	139	14331	4	0	2	145	14331	4	0	2	145	14182	4	0	2	144	14928	4	0	2	151
		FN	14972	5	0	1	152	15623	5	0	1	158	15623	5	0	1	158	15460	5	0	1	157	16274	5	0	1	165
		FM	14991	5	0	1	152	15642	5	0	1	159	15642	5	0	1	159	15480	5	0	1	157	16294	5	0	1	165
FW	15077	4	0	1	153	15733	4	0	1	160	15733	4	0	1	160	15569	4	0	1	158	16388	4	0	1	166		
96LD	530 mA (152.1W)	T1	21128	5	0	5	139	22047	5	0	5	145	22047	5	0	5	145	21817	5	0	5	143	22966	5	0	5	151
		T2	20917	3	0	4	138	21827	3	0	4	144	21827	3	0	4	144	21599	3	0	4	142	22736	3	0	4	150
		T3R	21012	3	0	4	138	21926	3	0	4	144	21926	3	0	4	144	21697	3	0	4	143	22839	3	0	4	150
		T3	20535	3	0	3	135	21428	3	0	3	141	21428	3	0	3	141	21205	3	0	3	139	22321	3	0	3	147
		T3W	21264	3	0	3	140	22189	3	0	3	146	22189	3	0	3	146	21958	3	0	3	144	23114	3	0	3	152
		T3LG	21151	3	0	3	139	22071	3	0	3	145	22071	3	0	3	145	21841	3	0	3	144	22990	3	0	3	151
		T4	20808	3	0	3	137	21712	3	0	3	143	21712	3	0	3	143	21486	3	0	3	141	22617	3	0	4	149
		T4A	22038	3	0	2	145	22997	3	0	3	151	22997	3	0	3	151	22757	3	0	3	150	23955	3	0	3	158
		T4LG	21089	3	0	3	139	22006	3	0	3	145	22006	3	0	3	145	21776	3	0	3	143	22923	3	0	3	151
		T5	21971	4	0	2	144	22926	4	0	2	151	22926	4	0	2	151	22687	4	0	2	149	23882	4	0	2	157
		T5LG	21297	4	0	2	140	22223	4	0	2	146	22223	4	0	2	146	21991	4	0	2	145	23149	4	0	2	152
		T5W	21413	5	0	3	141	22344	5	0	3	147	22344	5	0	3	147	22111	5	0	3	145	23275	5	0	3	153
		T5WW	20327	5	0	3	134	21211	5	0	3	139	21211	5	0	3	139	20990	5	0	3	138	22094	5	0	3	145
		FN	22160	5	0	1	146	23123	5	0	1	152	23123	5	0	1	152	22882	5	0	1	150	24086	5	0	1	158
		FM	22187	5	0	1	146	23152	5	0	1	152	23152	5	0	1	152	22910	5	0	1	151	24116	5	0	1	159
FW	22315	4	0	1	147	23285	4	0	1	153	23285	4	0	1	153	23043	4	0	1	152	24256	4	0	1	160		
96LD	700 mA (203.8W)	T1	27386	5	0	5	134	28577	5	0	5	140	28577	5	0	5	140	28279	5	0	5	139	29768	5	0	5	146
		T2	27112	3	0	4	133	28291	4	0	5	139	28291	4	0	5	139	27997	4	0	5	137	29470	4	0	5	145
		T3R	27235	4	0	4	134	28419	4	0	5	139	28419	4	0	5	139	28123	4	0	5	138	29604	4	0	5	145
		T3	26618	3	0	3	131	27775	3	0	4	136	27775	3	0	4	136	27485	3	0	4	135	28932	3	0	4	142
		T3W	27562	3	0	4	135	28761	3	0	4	141	28761	3	0	4	141	28461	3	0	4	140	29959	3	0	4	147
		T3LG	27416	3	0	4	135	28608	3	0	4	140	28608	3	0	4	140	28310	3	0	4	139	29800	3	0	4	146
		T4	26971	4	0	4	132	28143	4	0	4	138	28143	4	0	4	138	27850	4	0	4	137	29316	4	0	4	144
		T4A	28566	3	0	3	140	29808	3	0	3	146	29808	3	0	3	146	29497	3	0	3	145	31050	3	0	3	152
		T4LG	27335	3	0	4	134	28523	3	0	4	140	28523	3	0	4	140	28226	3	0	4	138	29712	3	0	4	146
		T5	28478	5	0	3	140	29716	5	0	3	146	29716	5	0	3	146	29407	5	0	3	144	30955	5	0	3	152
		T5LG	27604	4	0	2	135	28805	4	0	2	141	28805	4	0	2	141	28505	4	0	2	140	30005	5	0	2	147
		T5W	27755	5	0	3	136	28962	5	0	3	142	28962	5	0	3	142	28660	5	0	3	141	30168	5	0	3	148
		T5WW	26347	5	0	3	129	27493	5	0	4	135	27493	5	0	4	135	27206	5	0	4	133	28638	5	0	4	141
		FN	28723	5	0	1	141	29972	5	0	1	147	29972	5	0	1	147	29659	5	0	1	146	31220	5	0	1	153
		FM	28758	5	0	1	141	30009	5	0	1	147	30009	5	0	1	147	29696	5	0	1	146	31259	5	0	1	153
FW	28924	5	0	1	142	30182	5	0	1	148	30182	5	0	1	148	29867	5	0	1	147	31439	5	0	1	154		

CRI Multiplier		
70 to 80 CRI	2700K, 3000K, 3500K, 4000K	5000K
	0.91	0.88
70 to 90 CRI	0.7	0.77

ODN-3 LED SPECIFICATIONS / Forward Optics																											
Led Count	Current & Watts	Distribution Type	70CRI																								
			27K					30K					35K					40K					50K				
			Lumens	B	U	G	LPW	Lumens	B	U	G	LPW	Lumens	B	U	G	LPW	Lumens	B	U	G	LPW	Lumens	B	U	G	LPW
128LD	350 mA (131.5W)	T1	18939	4	0	4	144	19763	4	0	4	150	19763	4	0	4	150	19557	4	0	4	149	20586	4	0	4	157
		T2	18750	3	0	4	143	19565	3	0	4	149	19565	3	0	4	149	19361	3	0	4	147	20380	3	0	4	155
		T3R	18835	3	0	4	143	19654	3	0	4	150	19654	3	0	4	150	19449	3	0	4	148	20473	3	0	4	156
		T3	18408	3	0	3	140	19208	3	0	3	146	19208	3	0	3	146	19008	3	0	3	145	20008	3	0	3	152
		T3W	19061	3	0	3	145	19890	3	0	3	151	19890	3	0	3	151	19683	3	0	3	150	20719	3	0	3	158
		T3LG	18960	3	0	3	144	19784	3	0	3	150	19784	3	0	3	150	19578	3	0	3	149	20608	3	0	3	157
		T4	18652	3	0	3	142	19463	3	0	3	148	19463	3	0	3	148	19260	3	0	3	147	20274	3	0	3	154
		T4A	19755	3	0	2	150	20614	3	0	2	157	20614	3	0	2	157	20399	3	0	2	155	21473	3	0	2	163
		T4LG	18904	3	0	3	144	19726	3	0	3	150	19726	3	0	3	150	19520	3	0	3	148	20547	3	0	3	156
		T5	19695	4	0	2	150	20551	4	0	2	156	20551	4	0	2	156	20337	4	0	2	155	21407	4	0	2	163
		T5LG	19090	4	0	2	145	19920	4	0	2	152	19920	4	0	2	152	19713	4	0	2	150	20750	4	0	2	158
		T5W	19194	4	0	2	146	20029	4	0	2	152	20029	4	0	2	152	19820	4	0	2	151	20863	5	0	3	159
		T5WW	18221	5	0	3	139	19013	5	0	3	145	19013	5	0	3	145	18815	5	0	3	143	19805	5	0	3	151
		FN	19864	5	0	1	151	20727	5	0	1	158	20727	5	0	1	158	20511	5	0	1	156	21591	5	0	1	164
		FM	19888	5	0	1	151	20753	5	0	1	158	20753	5	0	1	158	20537	5	0	1	156	21618	5	0	1	164
		FW	20003	4	0	1	152	20873	4	0	1	159	20873	4	0	1	159	20655	4	0	1	157	21742	4	0	1	165
128LD	530 mA (202.8W)	T1	28031	5	0	5	138	29250	5	0	5	144	29250	5	0	5	144	28945	5	0	5	143	30469	5	0	5	150
		T2	27751	4	0	4	137	28957	4	0	5	143	28957	4	0	5	143	28656	4	0	5	141	30164	4	0	5	149
		T3R	27877	4	0	5	137	29089	4	0	5	143	29089	4	0	5	143	28786	4	0	5	142	30301	4	0	5	149
		T3	27244	3	0	4	134	28429	3	0	4	140	28429	3	0	4	140	28133	3	0	4	139	29613	3	0	4	146
		T3W	28212	3	0	4	139	29438	3	0	4	145	29438	3	0	4	145	29131	3	0	4	144	30665	3	0	4	151
		T3LG	28061	3	0	4	138	29281	3	0	4	144	29281	3	0	4	144	28976	3	0	4	143	30501	3	0	4	150
		T4	27606	4	0	4	136	28806	4	0	4	142	28806	4	0	4	142	28506	4	0	4	141	30006	4	0	4	148
		T4A	29238	3	0	3	144	30510	3	0	3	150	30510	3	0	3	150	30192	3	0	3	149	31781	3	0	3	157
		T4LG	27978	3	0	4	138	29195	3	0	4	144	29195	3	0	4	144	28891	3	0	4	142	30411	3	0	4	150
		T5	29149	5	0	3	144	30416	5	0	3	150	30416	5	0	3	150	30099	5	0	3	148	31684	5	0	3	156
		T5LG	28254	4	0	2	139	29483	4	0	2	145	29483	4	0	2	145	29176	4	0	2	144	30711	5	0	3	151
		T5W	28408	5	0	3	140	29643	5	0	3	146	29643	5	0	3	146	29335	5	0	3	145	30879	5	0	4	152
		T5WW	26968	5	0	4	133	28140	5	0	4	139	28140	5	0	4	139	27847	5	0	4	137	29313	5	0	4	145
		FN	29399	5	0	1	145	30677	5	0	1	151	30677	5	0	1	151	30358	5	0	1	150	31956	5	0	1	158
		FM	29435	5	0	1	145	30715	5	0	1	151	30715	5	0	1	151	30395	5	0	1	150	31995	5	0	1	158
		FW	29605	5	0	1	146	30893	5	0	1	152	30893	5	0	1	152	30571	5	0	1	151	32180	5	0	1	159
128LD	700 mA (271.8W)	T1	36333	5	0	5	134	37913	5	0	5	140	37913	5	0	5	140	37518	5	0	5	138	39493	5	0	5	145
		T2	35970	4	0	5	132	37534	4	0	5	138	37534	4	0	5	138	37143	4	0	5	137	39098	4	0	5	144
		T3R	36133	4	0	5	133	37704	4	0	5	139	37704	4	0	5	139	37311	4	0	5	137	39275	4	0	5	145
		T3	35313	3	0	4	130	36849	3	0	4	136	36849	3	0	4	136	36465	3	0	4	134	38384	3	0	4	141
		T3W	36567	3	0	5	135	38157	3	0	5	140	38157	3	0	5	140	37760	3	0	5	139	39747	3	0	5	146
		T3LG	36372	4	0	4	134	37954	4	0	4	140	37954	4	0	4	140	37558	4	0	4	138	39535	4	0	4	145
		T4	35782	4	0	4	132	37338	4	0	5	137	37338	4	0	5	137	36949	4	0	5	136	38893	4	0	5	143
		T4A	37898	4	0	3	139	39546	4	0	3	146	39546	4	0	3	146	39134	4	0	3	144	41194	4	0	3	152
		T4LG	36265	4	0	4	133	37842	4	0	4	139	37842	4	0	4	139	37448	4	0	4	138	39418	4	0	4	145
		T5	37782	5	0	3	139	39425	5	0	3	145	39425	5	0	3	145	39014	5	0	3	144	41068	5	0	4	151
		T5LG	36623	5	0	3	135	38215	5	0	3	141	38215	5	0	3	141	37817	5	0	3	139	39807	5	0	3	146
		T5W	36822	5	0	4	135	38423	5	0	4	141	38423	5	0	4	141	38023	5	0	4	140	40024	5	0	4	147
		T5WW	34955	5	0	4	129	36474	5	0	4	134	36474	5	0	4	134	36095	5	0	4	133	37994	5	0	4	140
		FN	38106	5	0	2	140	39763	5	0	2	146	39763	5	0	2	146	39349	5	0	2	145	41420	5	0	2	152
		FM	38154	5	0	2	140	39812	5	0	2	146	39812	5	0	2	146	39398	5	0	2	145	41471	5	0	2	153
		FW	38374	5	0	1	141	40042	5	0	1	147	40042	5	0	1	147	39625	5	0	1	146	41711	5	0	1	153

CRI Multiplier		
70 to 60 CRI	2700K, 3000K, 3500K, 4000K	5000K
	0.91	0.88
70 to 90 CRI	0.7	0.77